

ARJO

SARA PLUS
THE ADVANCED STANDING
AND RAISING AID



**OPERATING AND PRODUCT
CARE INSTRUCTIONS**



KKX52180M-EN
Issue 2
October 2006

© ARJO

ARJO products are patented or patent pending.
Patent information is available by contacting ARJO.

The policy of Arjo is one of continuous development and we therefore reserve the right to make technical alterations without notice. The content of this publication may not be copied either whole or in part without the consent of ARJO.

This product has been manufactured for ARJO by :

Medibo Medical Products N.V.
Heikant 5
B-3930 Hamont-Achel
Belgium

'*Sara Plus*' and 'ARJO' are registered trademarks of GETINGE AB.

The SARA PLUS is produced in Belgium by MEDIBO MEDICAL PRODUCTS for GETINGE AB and sold under the ARJO brand.

Contents

SECTION	Page No.
Foreword	4
Safety Instructions	5
Intended Use.....	5
Product description/function	6-10
Parts referred to in this manual.....	6
Control Handset.....	7
Dual Control panel	7
Emergency stop button (red)	7
Reset button (green)	8
Automatic cutout	8
Automatic stop function	8
System failure lower override	8
Battery discharge indicator.....	8
Hour meter.....	8
Chassis castor Brakes	8
Straight line steering function (option).....	8
Arc-Rest.....	9
Foot support.....	9
Proactive pad	9
Lower leg straps	9
Adjustable width chassis legs.....	10
Commode Seat (accessory)	10
Using your <i>Sara Plus</i>	11-23
Using your <i>Sara Plus</i> for toileting and transport.....	11
Standing sling	12
Transfer and walking sling	14
Using the sling for transfer	14
Using the sling for walking practice	17
Scale (if fitted).....	20-23
Lifter Battery charging	24-25
Warnings for charging	24
General safety Practices for Batteries	24
Care of your <i>Sara Plus</i>	26-28
General lifter care	26
Environmental advice.....	27
Periodic Testing.....	27
Cleaning and disinfecting the toilet commode chair and frame (if fitted).....	27
Servicing advice	28
Labels	29
Technical Specification	30-31
Lifter Dimensions.....	31

Foreword

Thank you for purchasing ARJO equipment

Your *Sara Plus* is part of a series of quality products designed especially for hospitals, nursing homes and other health care uses.

We are dedicated to serving your needs and providing the best products available along with training that will bring your staff maximum benefit from every ARJO product.

Please contact us if you have any questions about the operation or maintenance of your ARJO equipment.

The touch panel label on the dual control panel displays several instruction symbols. The letter (i) shown on the open book icon indicates 'information', and is an instruction to always read the operating instructions before use. (See fig 1).

The expected operational life of your ARJO lifter is 10 (ten) years from the date of manufacture, providing the following conditions are adhered to:-

Conditions

- The unit is cared for and serviced in accordance with recommended, published "Operating and Product Care Instructions" and the "Preventive Maintenance Schedule".
- The unit is maintained to the minimum requirements as published in the "Preventive Maintenance Schedule".
- The servicing and product care, in accordance with ARJO requirements, must begin on first use of the unit by the customer.
- The equipment is used for its intended purpose only and is operated within the published limitations.
- Only ARJO designated spare parts should be used.

Consumables

The expected operational life for fabric slings and fabric stretchers is approximately 2 years from date of purchase. This life expectancy only applies if the slings and stretchers have been cleaned, maintained and inspected in accordance with the "ARJO Sling Information" documents, the "Operating and Product Care Instructions" and the "Preventive Maintenance Schedule".

The expected life for other consumable products, such as batteries, fuses, lamps, gel cushions, filters,

seal kits, seat inserts, mattresses, safety belts, padded covers, straps and cords is dependent upon the care and usage of the equipment concerned. Consumables must be maintained in accordance with published "Operating and Product Care Instructions" and the "Preventive Maintenance Schedule".

All references to the patient in these instructions refer to the person being lifted, and reference to the attendant refer to the person who operates the lifter.

References to left and right of the lifter in these instructions are as viewed from the rear of the *Sara Plus*, i.e. viewed from the dual control panel (see Fig. 1)

Lifting operations in these instructions are described as if lifting a patient from a chair, the same operations can be performed effectively when lifting a patient from a wheelchair or sitting position on a bed, although a second attendant should support the patient if the patient lacks sitting balance.

All operations in these instructions are described as if the attendant were using the control handset. Each operation described can be controlled using the control handset and/or the dual switch panel, situated at the rear of the mast.

The *Sara Plus* is manufactured to a very high standard, and primarily designed to assist patients when standing and toileting, for use as a short distance patient transfer aid, and for standing and walking practice.

When used as a standing aid the *Sara Plus* is extremely useful for quick easy transfers from one sitting position to another, and to elevate a patient for toileting, repositioning, changing of incontinence pads or wound dressings, standing practice etc. it is not intended for long periods of suspension or transportation.

Some information contained in these instructions may become outdated, due to improvements made to this product in the future. If you have any questions regarding these instructions or your lifter, please contact ARJO or their approved distributor.

Safety Instructions

Symbols used adjacent to the text in these instructions:-

 **Warning:** Means:- failure to understand and obey this warning may result in injury to you or to others.

 **Caution:** Means:- failure to follow these instructions may cause damage to all or parts of the system or equipment.

• **Note:** Means:- *this is important information for the correct use of this system or equipment.*

This product has been designed and manufactured to provide you with trouble free use, however, this product does contain components that with regular use are subject to wear.

 **Warning:** SOME OF THESE PARTS ARE SAFETY CRITICAL TO THE OPERATION OF THE LIFTER AND WILL NEED EXAMINING AND SERVICING ON A REGULAR BASIS AND MUST BE REPLACED WHEN NECESSARY. See also “Care of your Sara Plus” section.

 **Warning: IMPORTANT:** When using the transfer and walking sling for the transfer operation the maximum lifting capacity is 140Kg (308lbs). When using the same sling for walking practice the maximum lifting capacity is 190Kg (420lbs). Do not exceed these weight limits.

 **Warning:** It is advisable to familiarise yourself and understand the operation of the various controls and features of the *Sara Plus* as described in “Product Description/Function” section in this manual and ensure that any action or check specified is carried out before commencing to lift a patient.

INTENDED USE

Sara Plus is a standing and raising aid for short transfers e.g. raising from bed and transfer to wheelchair, or from wheelchair to toilet. Sara Plus is also suitable for walking training when the footboard and kneepad are removed.

Sara Plus is intended to be used in hospitals, nursing homes or other health care facilities for the different categories of residents/patients

Category C, where the resident/patient
"Sits in a wheelchair
"Is able to partially bear weight on at least one leg
"Has some trunk stability
"Is dependent on the caregiver in most situations
"Need mobility-maintaining standing exercises

Or, Category D, where the resident/patient

"Sits in a wheelchair
"Is dependent on the caregiver in most situations
"SARA Plus is the only standing and raising aid where a resident/patient such as Category D, can safely be raised and transferred. The unique support of the EPS (Extra Postural Support) /BOS sling makes it feasible.

Sara Plus shall always be handled by a trained caregiver and in accordance with the instructions outlined in these Operating and Product Care Instructions.

Sara Plus is intended to be used with specifically designed ARJO slings

Lifting operations in these instructions are described as if lifting a patient from a chair, the same operations can be performed effectively when lifting a patient from a sitting position on a bed, although a second attendant should support the patient if the patient lacks sitting balance.

 **Caution:** Although manufactured to a high standard the *Sara Plus* and accessories should not be left for extended periods in humid or wet areas.

Do not under any circumstances spray the *Sara Plus* or accessories (excluding slings) with water e.g. under the shower.

Product Description/Function

Parts referred to in this manual

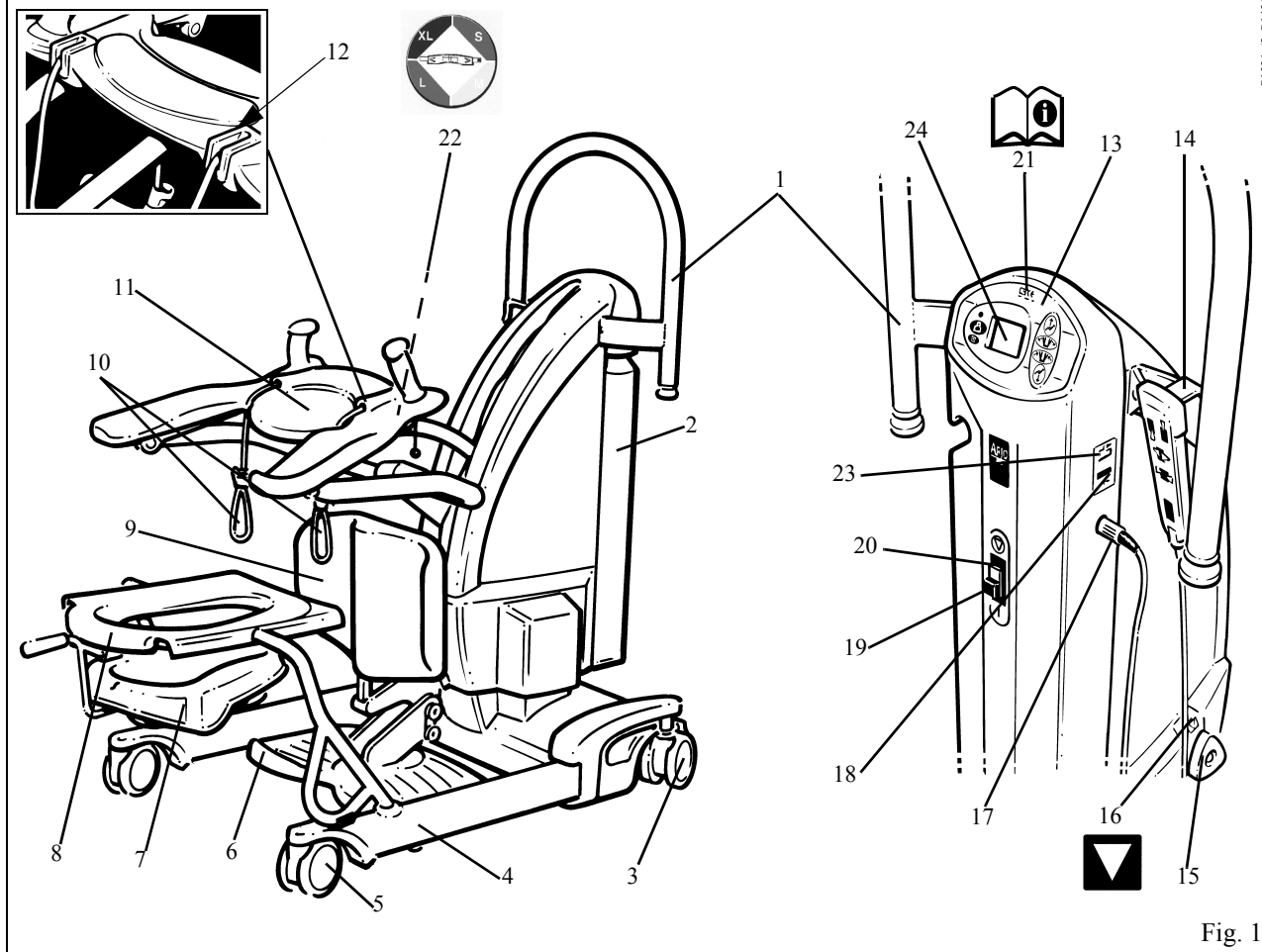

Fig. 1

- | | |
|---|--|
| 1. Manoeuvring handle | 16. Label - System failure lower override identification |
| 2. Battery pack | 17. Handset cable connection |
| 3. Braked castors (rear) | 18. Battery discharge indicator |
| 4. Chassis legs | 19. Reset button (green) |
| 5. Front castors (unbraked) | 20. Emergency stop button (red) |
| 6. Foot support (removeable) | 21. Label - Read operating instructions before use |
| 7. Commode pan (optional) | 22. Label - Sling size guide |
| 8. Commode seat and frame (optional) | 23. Hour meter |
| 9. Proactive Pad™ (Adjustable) | 24. Scale display panel (if fitted) |
| 10. Sling attachment cords | |
| 11. Arc-Rest™ (Supportive arm rests with handgrips) | |
| 12. Detail view of cord locking cleats | |
| 13. dual control panel | |
| 14. Control handset | |
| 15. System failure lower override knob | |

Product Description/Function

Unpack the battery pack supplied, and fully charge it as described in “Battery Charging section”.

When the battery pack is charged, disconnect the mains power, then remove the pack from the charger and insert it fully into the *Sara Plus* battery position, located at the left hand side of the lifter. Locate the recess in the bottom of the battery with the protrusion at the bottom of the battery position then pivot the battery into position until the retaining catch operates. Electrical connection is made automatically.

Ensure that the green reset button situated on the back of the lifter cover is pressed in. (see inset to Fig. 1).

Check that the system failure lower override knob is turned fully clockwise and finger tight, (see Fig. 1).

Ensure that both sling types are available for the types of lift likely to be encountered when using the *ARJO Sara Plus*.

Two types of sling can be used with the *Sara Plus*.

Standing Sling – a single loop, used for supporting patients at the toilet, and to aid in the standing process. The sling has a ‘fleece’ cover for added comfort, which can be easily removed for cleaning.

Transfer and Walking Sling – A loop sling with back, buttock and leg support, used for easy and comfortable transporting of patients over short distances without the need for the detachable seat frame. By using different attachment straps the same sling can be used for supporting patients during the training procedure of standing, stepping and walking under the supervision of trained nursing staff. The sling has variable adjustment.

Note: The slings have colour coded connection loops for size identification, as follows:-

- Red - Small (S)
- Yellow - Medium (M)
- Green - Large (L)
- Blue - Extra Large (XL)

A circular label is fitted to the central lifting tube for quick colour to size reference. (see fig 1)

Controls and Features

Control handset:- Is a semi-remote control unit attached to the lifter by an extending cable. The handset controls lift and lower and chassis leg opening/closing. Direction arrows adjacent to the buttons indicate each function. (See Fig. 2). If pressure is released from any button during use, powered movement will stop immediately.

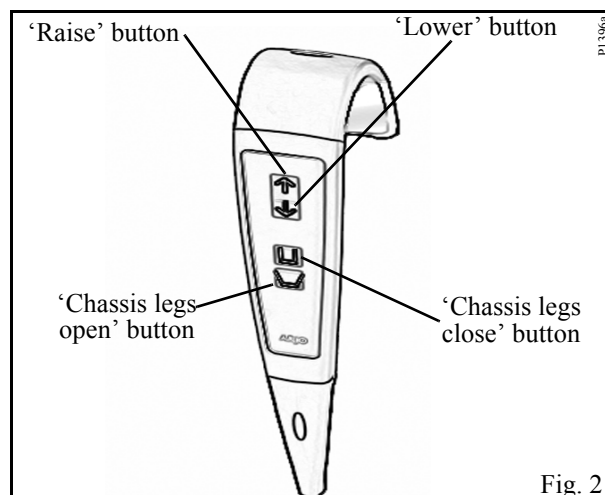

Fig. 2

Dual control panel:- offers the same controls as the handset and is conveniently positioned on the top of the main body of the lifter (See Fig. 3).

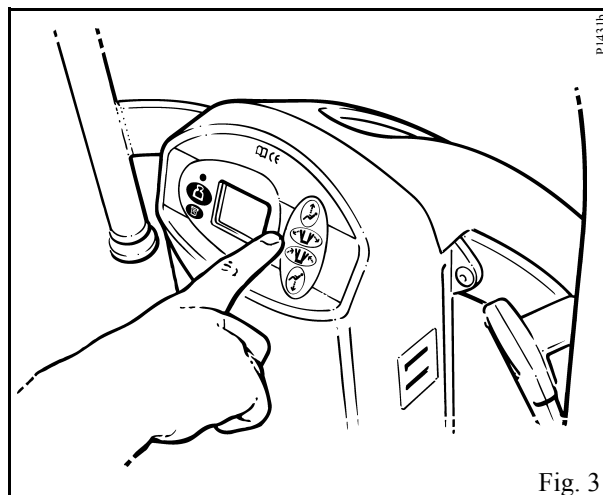

Fig. 3

Emergency stop button (red):- (see fig 1) If, in an emergency, you have to immediately stop any powered movement, (other than by releasing pressure on the button either on the handset or dual control panel), press the “emergency stop button situated on the back of the cover below the dual control panel. (See Fig. 1). This function can also be utilised to ensure that no powered operation is accidentally used when either transporting the lifter, or leaving the lifter in store or unattended.

Product Description/Function

Once the emergency stop button has been operated, the green reset button will have to be re-engaged by pressing it in, before any powered movement can be utilised.

Reset button (green):- (see Fig. 1) Adjacent to the emergency stop button. It is used to reset the 'power on' condition, once the emergency stop button has been operated, also used to reset if the automatic overload fuse has operated (indicated by the reset button projecting outwards slightly). If the fuse has operated and once reset, operates again, withdraw the lifter from use and contact ARJO Service department or their appointed distributor.

Automatic cut out:- (not an operator control but a function built into the lifter electronics):-

If the lifter is inadvertently overloaded (trying to lift a patient heavier than permitted), an automatic 'cut out' operates to prevent the lifter raising a load in excess of one and a half times the maximum rated load; this will stop the lift motion automatically.

If this occurs, when pressure is released from the lift button on the handset or dual control the electronics will reset and enable the patient to be lowered only, by pressing either lower button. Remove the patient from the lifter.

Automatic stop function:- Great care should be taken not to lower the patient support arms onto the patient or any other obstruction but if this should happen inadvertently the motor will continue to run but downward movement will be held by the obstruction. If this occurs release pressure from the 'lower' button immediately, operate the 'raise' button until clear, then remove the obstruction.

System failure lower override:- This can be used in the event of main control failure. In the unlikely event that the control handset or dual control panel fails to operate the lifter, with a patient still supported by the sling, provision for lowering has been made, using the "lower override knob", situated on the right hand side of the main cover (see Fig. 4). A label situated above the switch is for quick and easy recognition (see Fig. 1) To operate the lower override, turn the knob anti clockwise half a turn, to cease lowering turn the knob clockwise until finger tight only (do not over tighten), only use this knob in the event of normal control failure do not use it for normal function lowering.



Warning: Before operating the lower override to lower a patient, always ensure that a chair or suitable support is underneath ready to accept the patient.

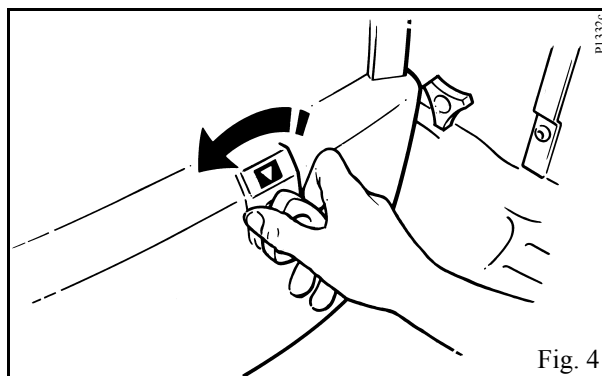

The lower override will operate whether the emergency stop button has been operated or not. The "automatic stop function" of the jib will still operate when using the lower override knob.

When using the *Sara Plus* normally, always ensure the system failure lower override knob is always turned fully clockwise and finger tight.

Battery Discharge Indicator:- is a small LED display which shows the charge condition of the lifter battery. (See Fig. 1 and also 'Battery Charging Section' for complete description).

Hour Meter:- Is a small LCD display (See Fig. 1) which shows the total duration of powered operation (in hours). This is primarily intended as an aid to service engineers and to help the attendant calculate servicing intervals.

Chassis castor Brakes:- The chassis rear castors have brakes which can be foot operated if required, (see Fig. 5) for example, when leaving the patient unattended, or to keep the *Sara Plus* in position.

Straight line steering function :- When using the *Sara Plus* for walking practice it may be considered useful to fix one of the castors to steer in a straight line. This has the effect of allowing the *Sara Plus*, without assistance to follow the intended straight line walked by the patient. The function is activated by flipping over the steering guide on the rear castor to hold it in position (see Fig. 5).

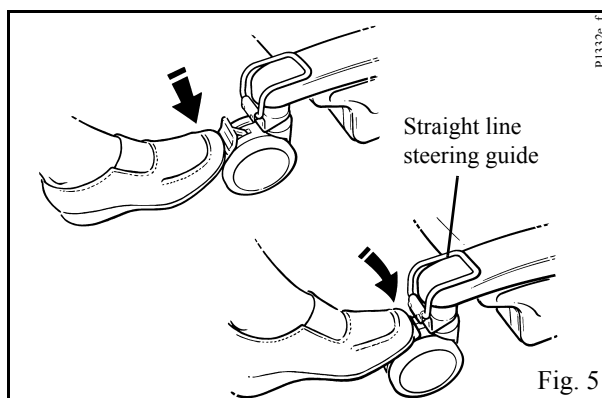

Product Description/Function

Arc-Rest (with handgrips):- Integral Part of the Lifting mechanism of the lifter, the intuitive and supportive armrests allow patient participation and comfort during the lifting procedure. (See Fig. 1)

Foot Support:- For positioning the patient's feet when lifting and transporting, it can be removed if using the *Sara Plus* to lift a patient to their feet prior to them using a walking aid eg. "Zimmer" etc. To remove the foot support, raise the Proactive knee support to its highest position, (note: where installed, unclip one side of the "Velcro" tie strap from around the foot support cover and slide the cover up the knee support column). Position yourself between the chassis legs and grip both sides of the foot support, lift up the front half of the foot support until it just comes into contact with the foot support bracket (see fig. 6), whilst it is in this position pivot the rear of the foot support upwards until the foot support is horizontal. Pull the foot support towards yourself until it is clear of the foot support bracket. Store carefully for future use.

Slide the foot support cover back down into position and secure using the "Velcro" strap. Re-adjust the Proactive kneepad to the position required.

Re-fitting the foot support is achieved by reversing the above procedure. Note: Ensure the two hooks on the foot support locate over the top two locating buttons.

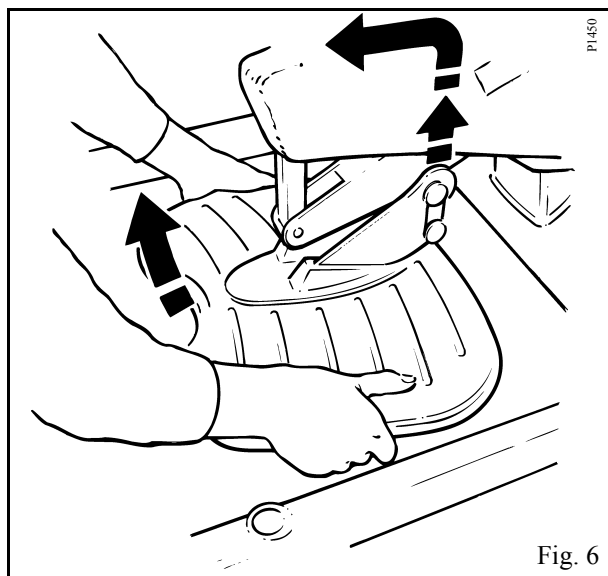

Proactive Pad™:- This is a reactive lower leg support (Fig. 1 and 7), which enables the patient to be lifted comfortably and effortlessly. It can be adjusted vertically for differing lower leg lengths and is sprung to stay in contact, when the patient's

legs move radially during the lifting procedure. To adjust, hold the Proactive Pad™ with one hand (see Fig. 7) and slacken the clamping screw knob with the other hand. When the correct height has been established re-tighten the knob.

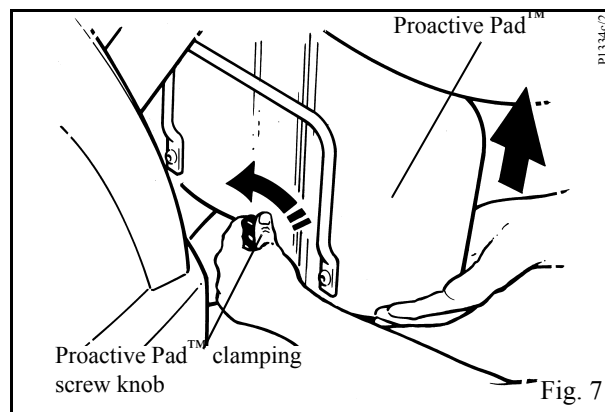

It can be removed from its mount quickly, for walking practice, simply by lifting upwards, after the foot support has been removed.

Lower leg Straps:- An optional accessory used for ensuring the lower parts of the patient's legs stay in close proximity to the Proactive Pad™ for correct lifting procedure.

The Strap ensures the lower parts of the patient's legs stay in close proximity to the Proactive Pad for correct lifting procedure. The strap is held in position in relationship to the Proactive Pad by passing through the guides on the back of the Proactive Pad then around the patients lower calves to be finally overlapped and pressed together to join the "velcro" fastening. (See Fig. 8). Ensure the strap is firm but comfortable for the patient

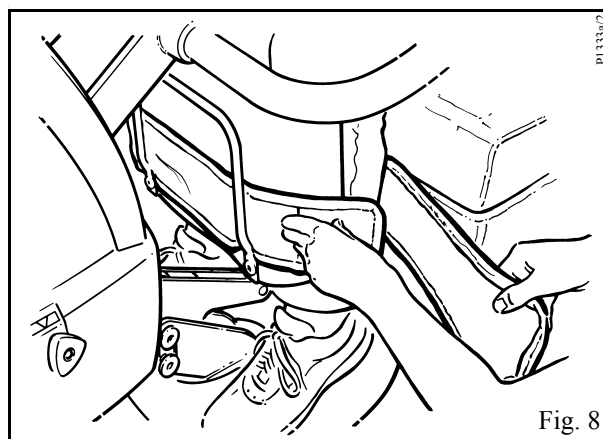

Product Description/Function

Adjustable width chassis legs:- By operating the appropriate button on either the control handset or dual control panel on the lifter the chassis legs can be opened to any variable width (See Fig. 9). When pressure is released from the button, movement will stop and the chassis legs will remain securely in position.

- **Note:** Transportation should be done with the chassis legs closed, it will be easier through doorways etc.

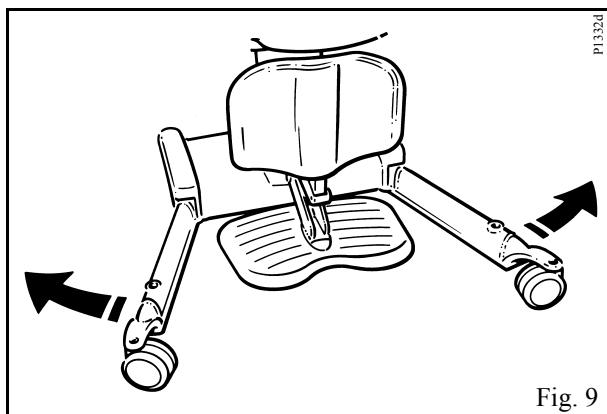

Warning: At all times the patient and/or operator should not allow their feet or any other part of their body to be placed in the area between the foot support and chassis legs when the chassis legs are closing.

Commode Seat (Accessory)

For toileting patients at the chair or bedside or for patients who cannot be transported with the transfer sling, the use of the commode seat and frame is the recommended method of transporting patients over longer distances. The commode frame is inserted into the holes in the chassis legs (see Fig. 10), once the patient has been lifted to a standing or near standing position in the manner previously described.

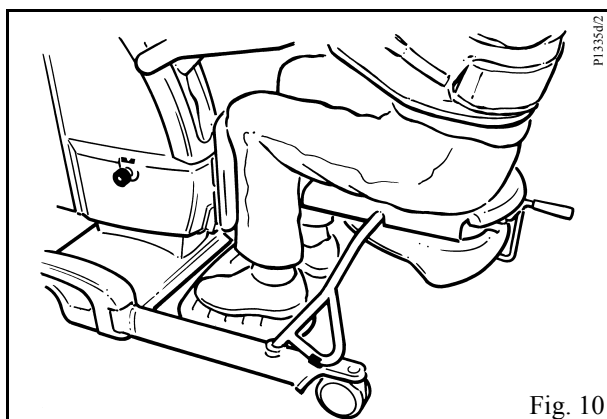

Removal of any clothing can be attended to, and the patient is then lowered down onto the commode seat. It is recommended that the patient is kept supported by the sling.

The retractable commode pan, accessible from the rear of the seat, (see Fig. 11), may be utilised, or removed to enable the patient to be positioned over a toilet. Apply chassis brakes if leaving the patient unattended.

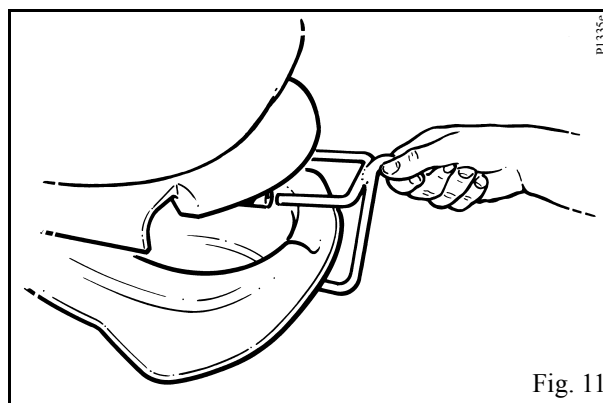

Using your Sara Plus

Using the Sara Plus for Toileting and Transporting

Before approaching the Patient the attendant should always tell the patient what they are going to do, and have the correct size and type of sling ready. (See description of sling types in the “Introduction” section.)

Although the sling can be fitted to the patient with the Sara Plus in close proximity it may be considered easier to fit the sling to the patient with the Sara Plus away.

Once the sling has been fitted (see following sections) the Sara Plus may be brought to the patient as follows:-

Adjust the height of the Patient Support arms to be raised or lowered sufficiently to avoid approaching the patient at eye level, making allowances for the patients arms and any obstructions, e.g. chair arms etc.

Approach the patient from the front with the lifter, stop before the foot support and Proactive Pad™ are in contact with the patient. (See Fig. 12)

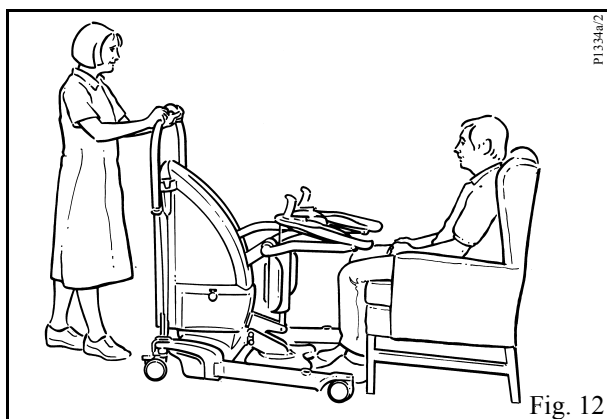

- **Note:** If required, the chassis legs may be opened to go around the chair; by operating the appropriate button on the control handset or dual control on the lifter.

- **Note:** If the handset button or dual control button is released during any function, powered motion will stop immediately.

When the patient is ready, give assistance or allow the patient to place his/her feet on the foot support, pushing the Sara Plus towards the patient a little to achieve this easily. (See Fig. 13).

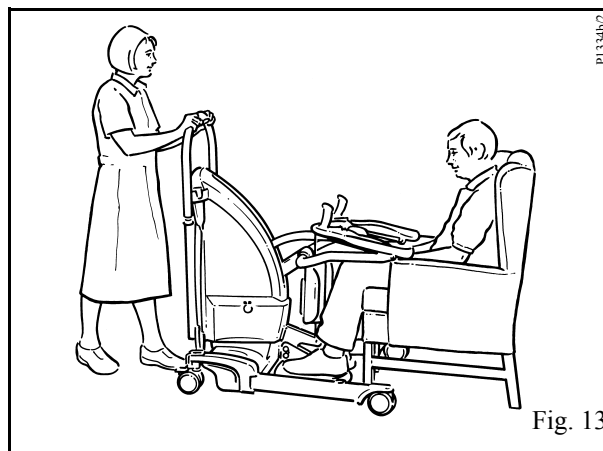

Adjust the Proactive Pad™ height (if necessary) – an approximate guide is to align the top of the Proactive Pad™ just below the patient's patella. (See Fig. 14).

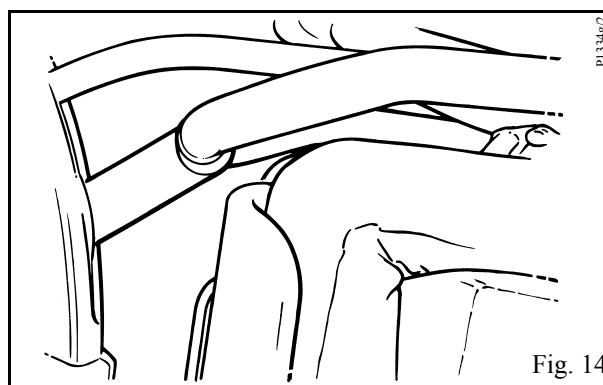

Carefully push the lifter in closer to make full lower leg contact with the Proactive Pad™ (see Fig. 15), then apply the chassis brakes.

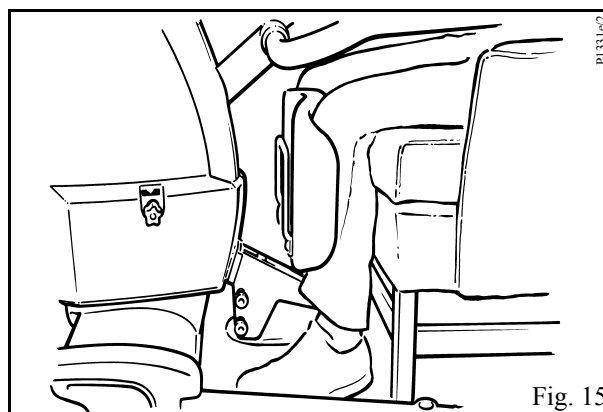

For the use of each individual type of sling see following sections: -

Using your Sara Plus

Standing Sling



Warning: Assessment will have to be made whether the patient requires the lower leg straps, apply if necessary.

Allow the patient to hold the handgrips, with their arms resting on the Arc-Rest. This will not apply if fitting the sling around the patient before the Sara Plus is brought into close proximity.

Encourage the patient to lean slightly forwards to enable the sling to be placed around the lower back of the patient (see Fig. 16). Position the sling around the patient's back so that the bottom of the sling lies horizontally approximately two inches above the patient's waistline, with the patient's arms outside the sling. Ensure the support strap is separated, brought loosely around the body, and is not twisted or trapped behind the patient's back.

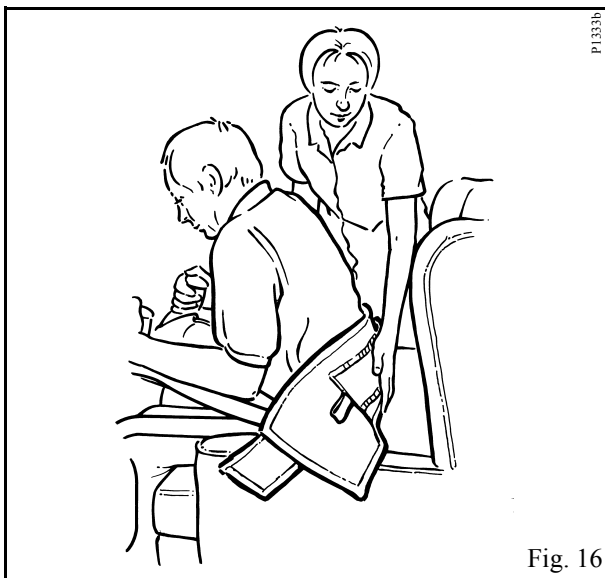

Fig. 16

Fasten the support strap securely by overlapping and pressing the "Velcro" together. The strap should be tight, but comfortable for the patient. (See Fig. 17).

- **Note:** As stated previously, the standing sling may be applied before the Sara Plus is brought into position as shown in figure 13.



Warning: The support strap must always be applied when using any of the slings.

- **Note:** The support strap will assist in supporting the patient in the sling during the lifting procedure. The strap also retains the sling in the correct position around the patient.

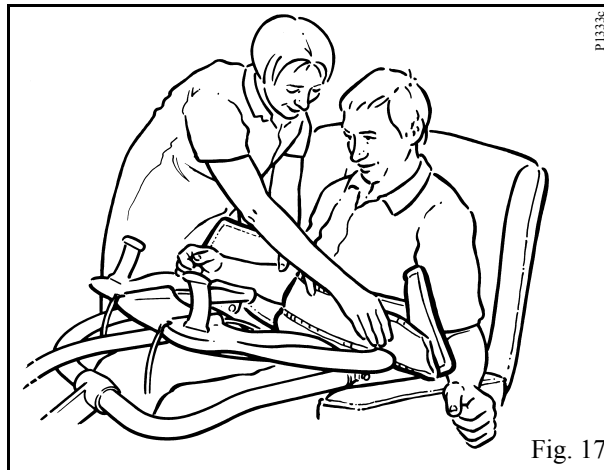

Fig. 17

If the Sara Plus is not already in close proximity to the patient bring it to the patient as described previously.

Take each adjustment cord in turn and attach to the sling. (See Fig. 18).

Fitting the Loop Lock cord attachment system

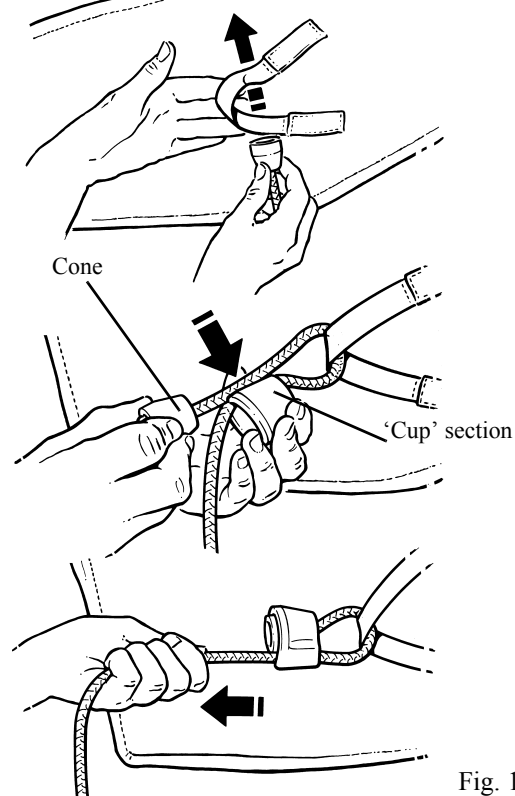

Fig. 18

Using your Sara Plus



Warning: Ensure the cone is pulled tightly into the cup section. (See Fig. 18).

When both cords are attached correctly make adjustments on both cords equally so that any slack is taken up in each cord and the back section of the sling supports the patient comfortably and securely, lock the adjustment cords down into the cord retaining cleats. (See Fig. 19).



Warning: Ensure the cord end knobs are away from the proactive pad™ when the patients legs are near or in contact with the pad.

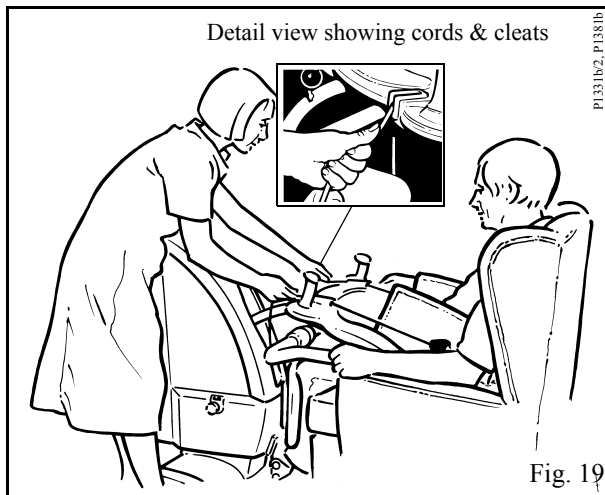

Fig. 19

- **Note:** The patient should be supported by the sling, but not pulled forward too much. (See Fig. 20)

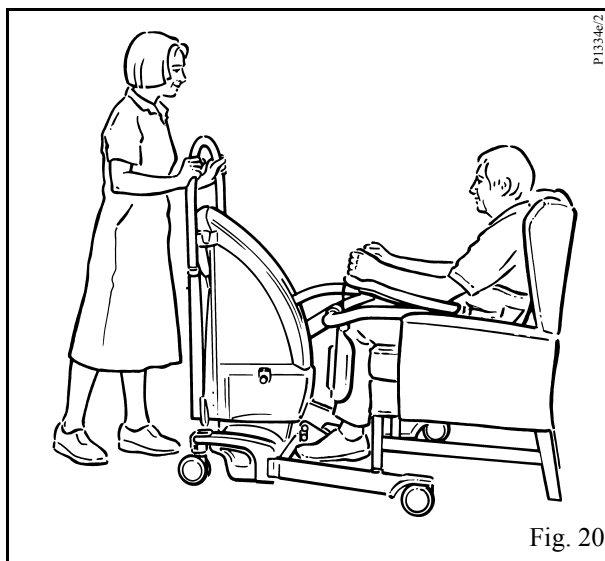

Fig. 20

If possible, the patient should then hold on to the Patient Support arms with one or both hands.

The patient is then ready to be lifted.

- **Note:** If the handset button or dual control button is released during lifting or lowering powered motion will stop immediately.

If the patient is able to offer some assistance when standing this may be beneficial to patient confidence and muscular exercise. Encourage the patient to assist all he/she can to raise from the chair and/or steady themselves.

Operate the lift button on the handset or dual control panel to raise the patient to a suitable and comfortable height for the particular function, e.g. transportation, toileting with commode, etc. (See Fig. 21)

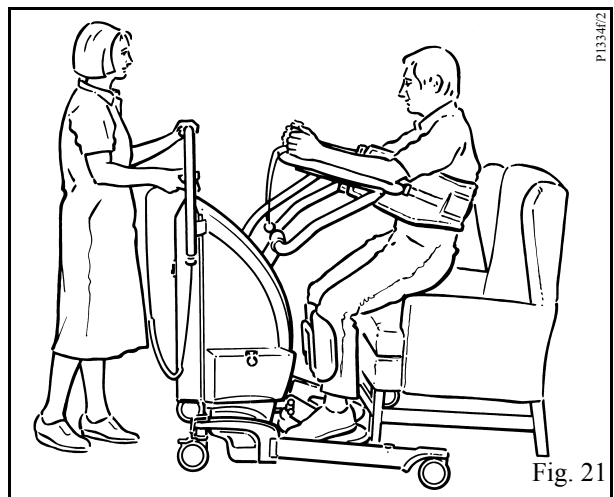



Fig. 21

IMPORTANT: Always check that the sling adjustment cords are fully in position and locked before and during the commencement of the lifting cycle, and in tension as the patient's weight is gradually taken up.

- **Note:** If the patient can stand sufficiently well and lock his/her knees in the normal way when fully raised, their knees will come away from the Proactive Pad™ and he/she will be able to lean back into the sling.

Patients who can only hold on with one hand, (those who have suffered a "stroke", for example) may still be lifted by using the Sara Plus. The patient may just rest the unusable arm on the Arc-Rest or hold it across their chest, and rest their elbow on the end of the Arc-Rest, while their useable hand holds the handset in the normal way.

Using your Sara Plus

 **Warning:** Only use this or other methods after a satisfactory professional assessment has been carried out on the individual patient.

If required insert the detachable seat frame into the receptor holes in the chassis legs, then lower the patient to a comfortable seating position for commode toileting or longer distance transportation. (See Fig. 22).

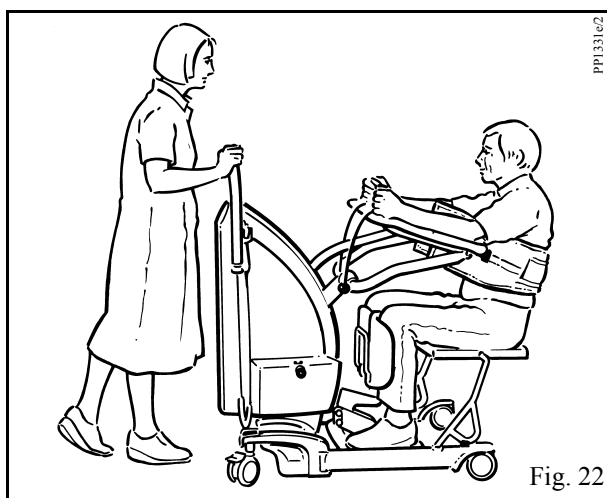



Fig. 22

- **Note:** The chassis legs will have to be adjusted to the closed position to fit the seat frame.

Release the brakes, and transfer the patient to new position, i.e., toilet, wheelchair, chair, bed, etc.

- **Note:** Transportation should be done with the chassis legs closed, it will be easier through doorways etc.

While the patient is raised, make any necessary adjustments to clothing, incontinence pads etc., before lowering again. Lower the patient carefully using the control handset or dual control panel.

 **Warning:** Apply the chassis brakes if leaving the patient at the toilet, or if leaving the patient unattended.

When the patient is seated in the new position, and you wish to remove the sling.

Pull each cord up from the locking cleats and slacken the cords sufficiently to release the Loop Lock™ fitting, then remove the cords from the sling.

Pull apart the “Velcro” fastening to remove the support strap.

 **Warning:** Do not attempt to release the support strap while the patient is supported by the sling.

Remove the sling from the patient.

Remove the lower leg straps if they have been applied.

 **Warning:** If the patient lacks sitting balance and has been returned to sit on the side of the bed a second attendant may be needed to support the patient while the sling is being removed.

Transfer and Walking Sling

Using the sling for transfer (140Kg - 308 lbs maximum patient weight):- The attendant should always tell the patient what they are going to do, and have the correct size and type of sling ready. (See description of sling types in the “Introduction” section.)

Encourage the patient to lean slightly forwards to enable the selected sling to be placed around the lower back of the patient (see Fig. 23). Position the sling around the patient’s back so that the bottom edge of the sling is level with the base of the spine. Ensure the patient’s arms are outside the sling and that the support strap is separated.

Take each leg section of the sling in turn and slide under each leg, (see Fig. 24).

Bring the support strap around the body and fasten securely by overlapping and pressing the “Velcro” together.

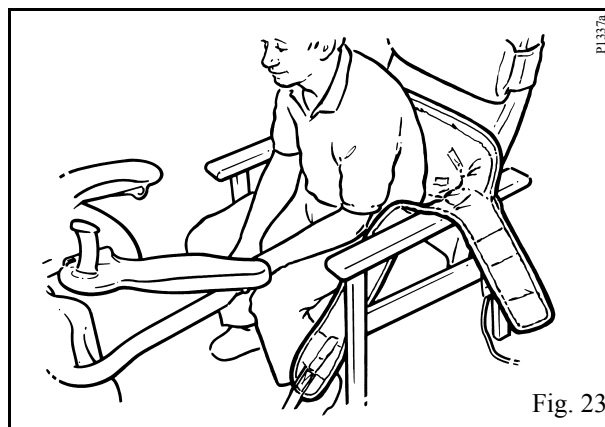
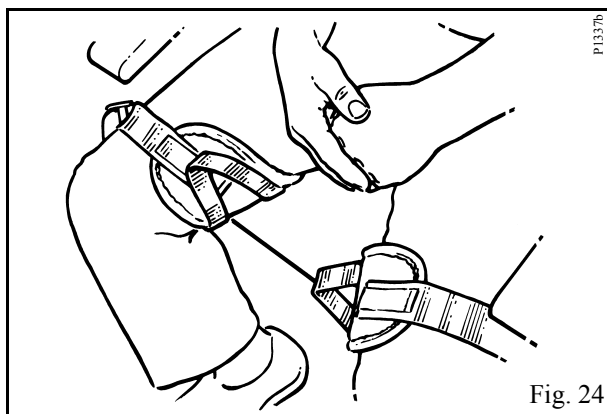

Fig. 23

Take each leg section of the sling in turn and slide under each leg, (see Fig. 25).

Using your Sara Plus



- **Note:** The support strap will assist in supporting the patient in the sling during the lifting procedure.

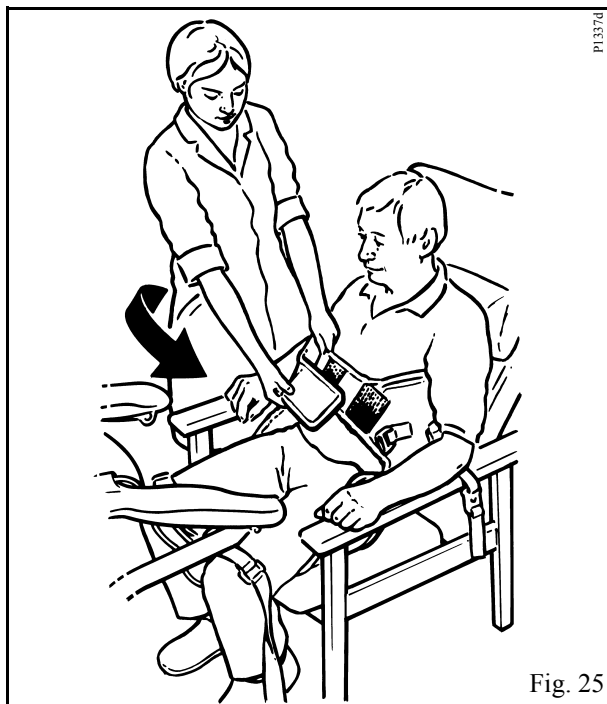

The strap should be tight but comfortable for the patient. (See Fig. 26).

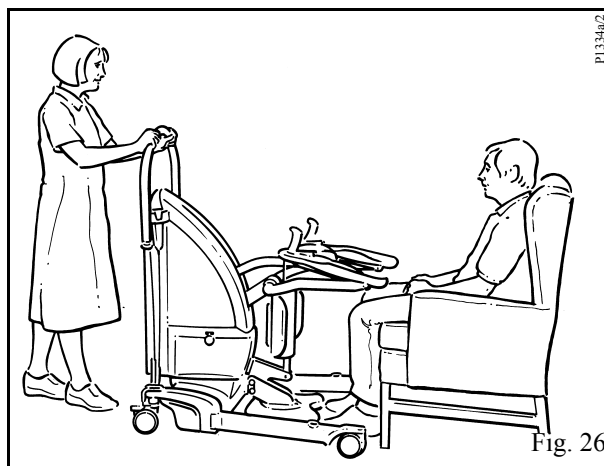

- **Note:** If required, the chassis legs may be opened to go around the chair, by operating the appropriate button on the control handset or dual control on the lifter.

- **Note:** If the handset button or dual control button is released during any function, powered motion will stop immediately.

Give assistance or allow the patient to place his/her feet on the foot support, pushing the Sara Plus towards the patient a little to achieve this easily. (See Fig. 27).

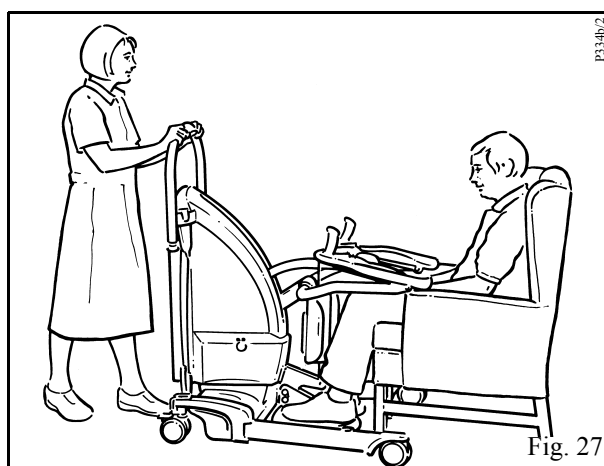

Adjust the Proactive Pad™ height (if necessary) - to align the top of the Proactive Pad™ just above the patients patella, or adjust the pad to its highest position. (see Fig. 28).

Using your Sara Plus

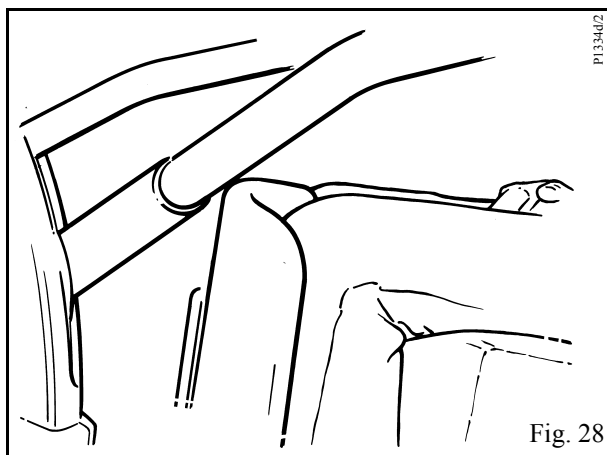

Identify the attachment loop on each side of the sling and attach the right hand adjustment cord to the left loop, repeat for the other side (see Fig. 29). See also Fig. 18 for attachment of the cords.

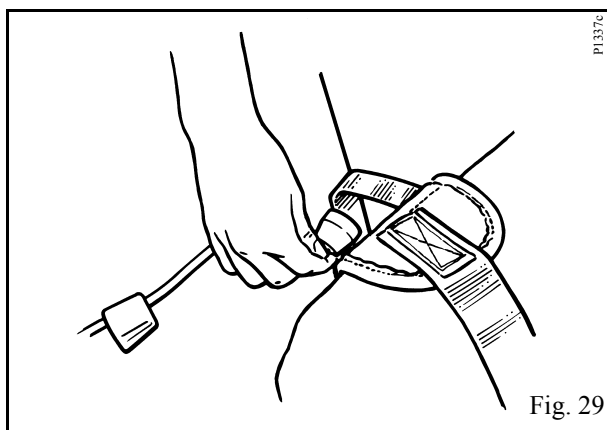

When both cords are attached correctly make adjustments on both cords equally so that any slack in the cord is taken up.



Warning: Lock the adjustment cords down into the cord retaining cleats (see also Fig. 30).



Warning: Ensure the cord end knobs are away from the proactive pad™ when the patients legs are near or in contact with the pad.

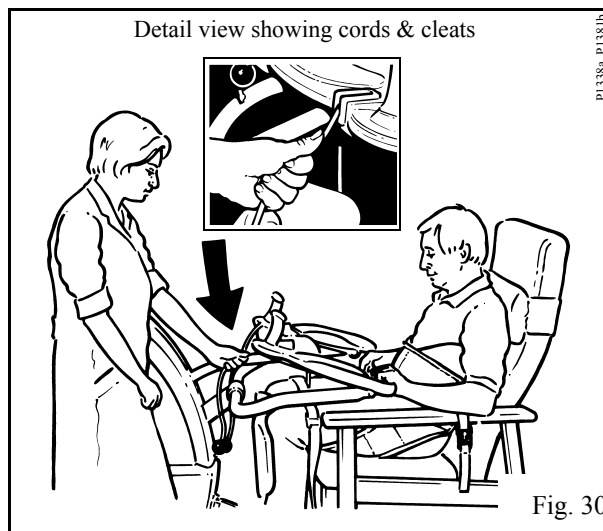

Identify the support strap on each side of the sling (fitted with a plastic attachment clip), and adjust both straps to their maximum length. Attach each clip to the lug situated on the outer sides of the Arc-Rest (see Fig. 31).

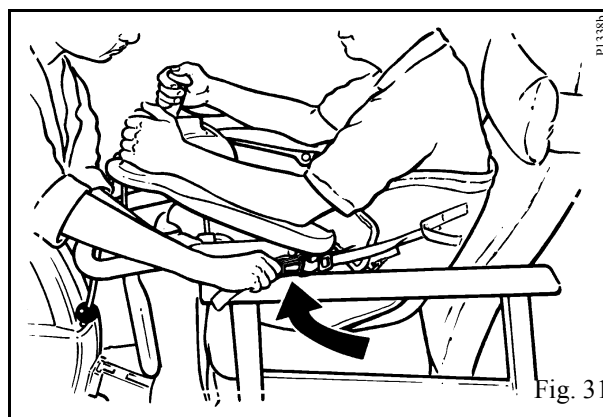

Warning: Ensure each clip is attached correctly and secure onto the lug.

Allow the patient to hold the hand grips with their arms resting on the Arc-Rest.

Operate the lift button on the handset or dual control panel, continue to raise until each support strap is in tension and the patient's back just comes away from the chair, then stop the lift. Then adjust both cords equally to take up any slack, lock both cords into the locking cleats. (See Fig. 32).

Continue raising until the patient is just clear of the seat.

Using your Sara Plus

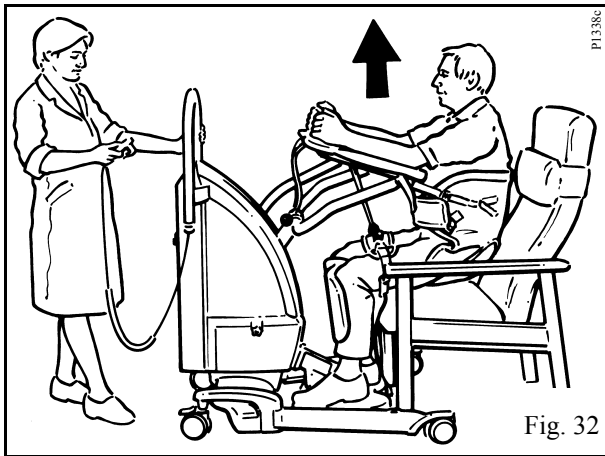

Fig. 32

If any discomfort is experienced by the patient return to the sitting position and re-adjust.



Warning: Important: Always check that the sling adjustment cords and support strap attachment clips are fully in position and locked before and during the commencement of the lifting cycle, and in tension as the patients weight is gradually taken up.

Be careful not to raise the patient too high as this will negate the comfort of the transfer sling.

Release the chassis brakes and close the chassis legs, then transport the patient to desired position. (See Fig. 33).

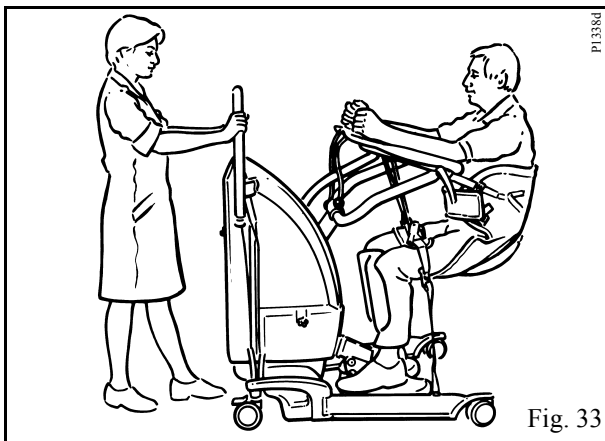

Fig. 33

Transportation should be done with the chassis legs closed, it will be easier through doorways etc.



Warning: Apply the chassis brakes if leaving the patient unattended.

Do not attempt to release the straps or cords while the patient is supported by the sling.

Using the sling for walking practice - (190Kg - 420 lbs maximum patient weight):-

Remove the foot support from the lifter and store carefully for future use (see "Product Description/Function" section in this manual).

As with all types of lift, before approaching the patient the attendant should always tell the patient what they are going to do, and have the correct size and type of sling ready.

Encourage the patient to lean slightly forwards to enable the selected sling to be placed around the lower back of the patient (see Fig. 23). Position the sling around the patient's back so that the bottom edge of the sling is level with the base of the spine. Ensure the patient's arms are outside the sling and that the support strap is separated. Bring the support strap around the body and fasten securely by overlapping and pressing the "Velcro" together. The strap should be tight but comfortable for the patient.

- **Note:** *The support strap will assist in supporting the patient in the sling during the lifting procedure.*

Take each leg section of the sling in turn and slide under each leg (See Fig. 25).

Pull up each leg section strap and connect to each corresponding body strap, by connecting both halves of the buckles securely (see Fig. 34).

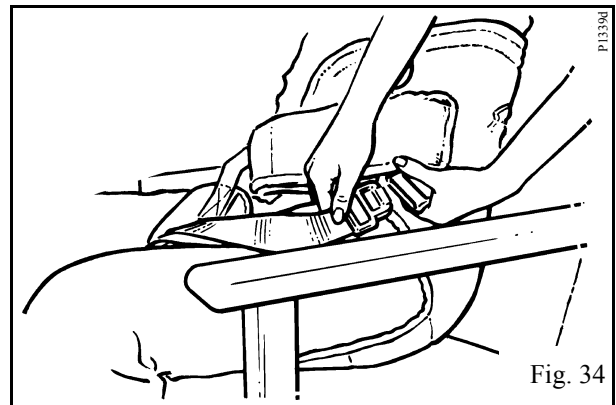

Fig. 34

Adjust the straps to be supportive but not restrictive for the patient. (See Fig. 35).

- **Note:** *The leg section strap connection can be performed after the patient has been lifted if preferred.*

Using your Sara Plus

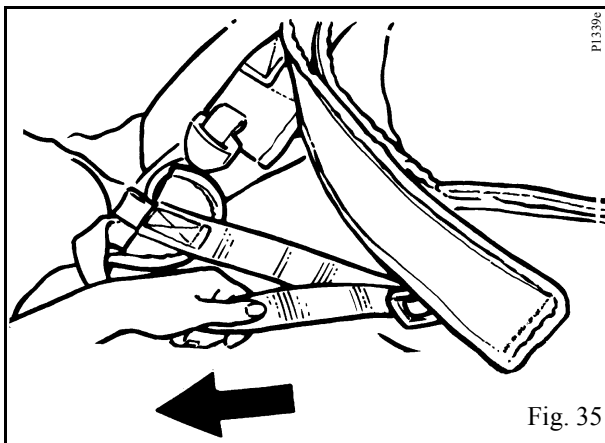

Fig. 35

Adjust the height of the Arc-Rest to be as low as possible, making allowances for obstructions, e.g. Chair arms etc.

Approach the patient from the front with the lifter; stop before the Proactive Pad is in contact with the patient. (See Fig. 36).

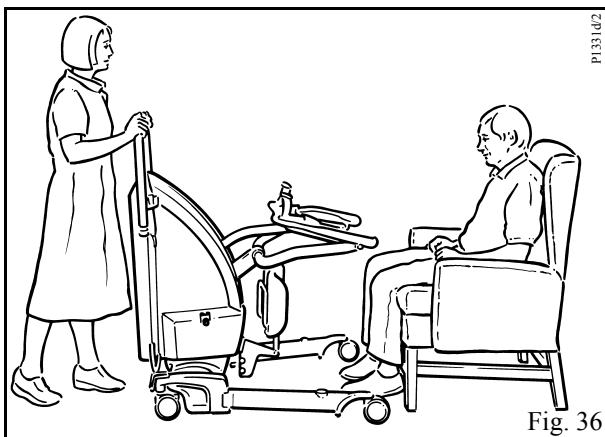

Fig. 36

- **Note:** If required, the chassis legs may be opened to go around the chair, by operating the appropriate button on the control handset or dual control on the lifter.

- **Note:** If the handset button or dual control button is released during any function, powered motion will stop immediately.

Adjust the Proactive Pad height (if necessary) - an approximate guide is to align the top of the Proactive Pad just below the patient's patella. (See Fig. 28).

Carefully push the lifter in closer to make full lower leg contact with the Proactive Pad, then apply the chassis brakes.

Identify the cord attachment loop on each side of the sling body and attach the cords (Loop Lock method as previously shown in Fig. 18). When both cords are attached correctly adjust both cords equally so that the slack is taken up, but does not pull the patient forward.



Warning: Lock the adjustment cords down into the cord retaining cleats. (See Fig. 37).

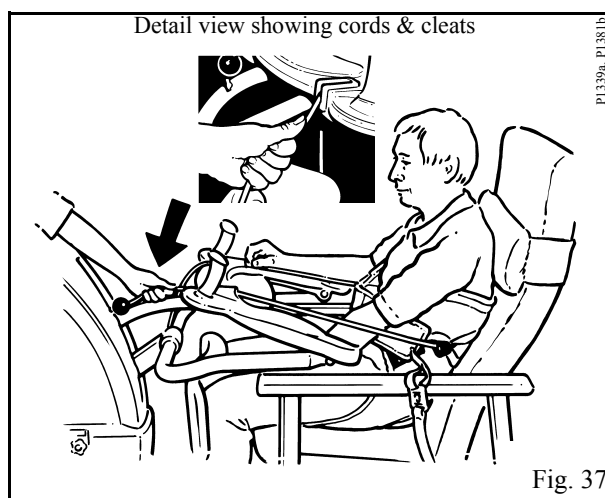

Fig. 37

Allow the patient to hold the handgrips with their arms resting on the Arc-Rest.

Slacken the adjustment on each body support strap (if required), enough to be able to connect the attachment clips to the lugs on the outer sides of the Arc-Rest (See Fig. 38).

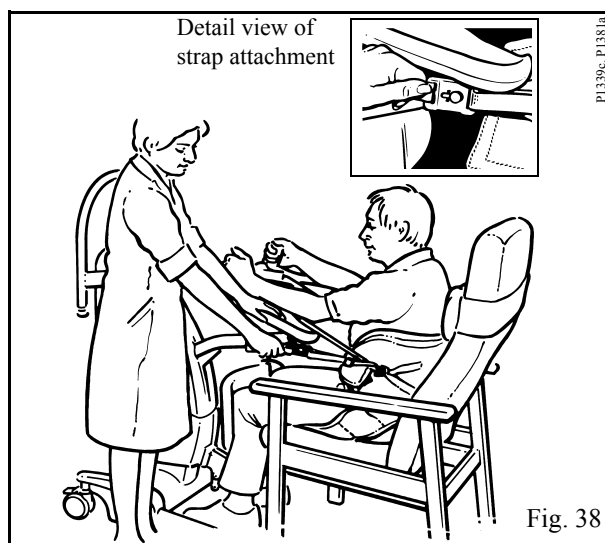
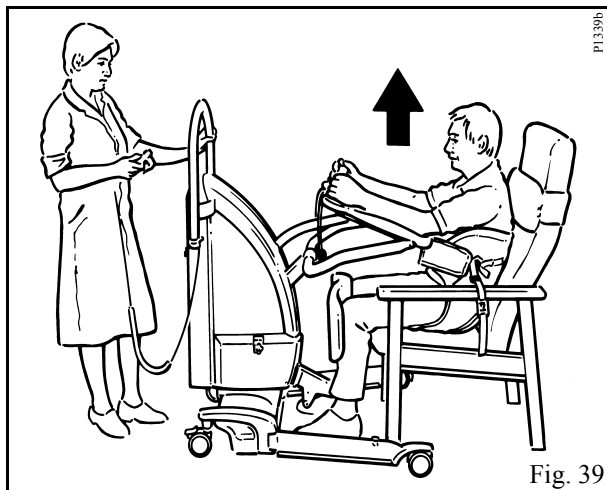

Fig. 38

Using your Sara Plus

When the patient is ready, operate the lift button on the handset or dual control to raise the patient, at the same time encourage him/her to actively stand (See Fig. 39).



Continue to raise the Arc-Rest until the patient is in a comfortably supported standing position (see Fig. 40).

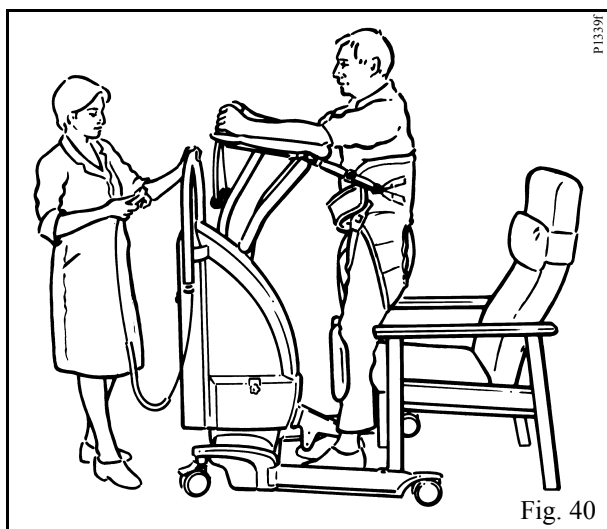

If walking practice is to be carried out ensure the patient is correctly and comfortably supported, adjust the body support straps equally to take up any slack and be supportive but not too tight and make adjustment to the Arc-Rest as necessary.

When the patient is standing confidently release the brakes and pull the lifter slightly away from the patient until the Proactive Pad is clear of the patients legs (see Fig. 41).

Re-apply the chassis brakes then carefully remove the Proactive Pad complete with attachment bracket by lifting upwards and store carefully for future use. (See Fig. 42).

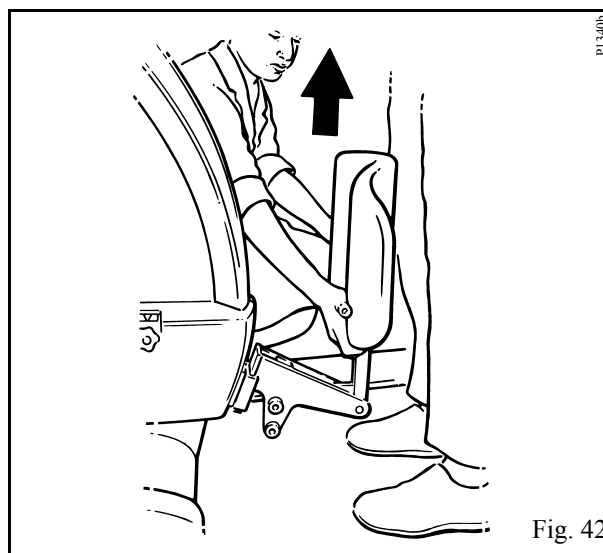
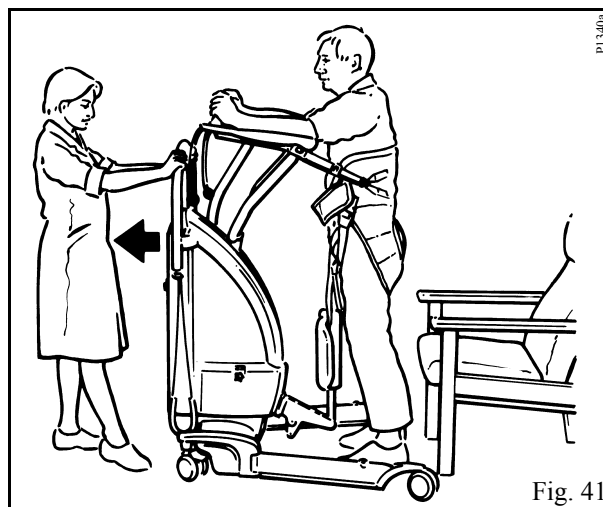

- **Note:** The chassis legs may be opened or left open to give better clearance for the patient.

- **Note:** The 'straight line' steering lock (if fitted) can be applied over the rear castor as an additional aid if required.

With the Pro-Active pad removed and the brakes released, the patient will be able to walk at their own pace, while being supported by the Sara Plus. (See Fig. 43).

Using your Sara Plus

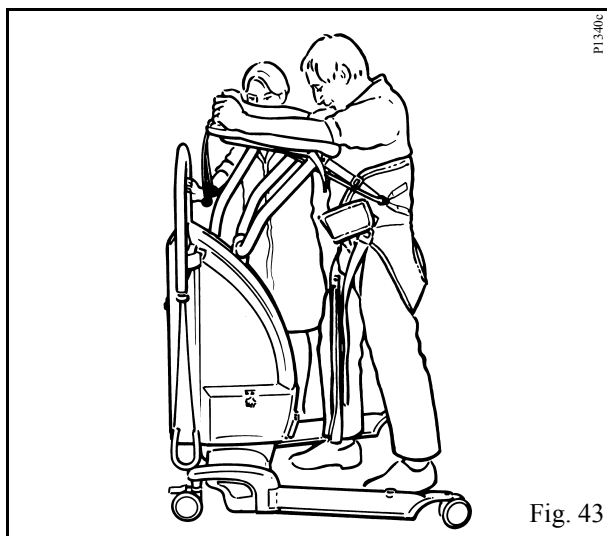

- **Note:** To have better flexion for the leg it may be necessary to slacken the leg straps slightly, this will allow better leg movement.



Warning: Do not separate the two halves of the buckles or release the adjustment cords at any stage other than when the patient is seated and fully supported.

Ensure there are no obstructions in the path before the patient is encouraged to walk.

Once walking practice has been completed, apply the chassis brakes and replace the Pro-Active pad, return the patient to a chair and when fully supported, remove the sling by reversing the fitting procedure.

ARJO Scale (if fitted)

If your Sara Plus has been supplied with the integral Scale unit (see Fig. 44), it is possible to weigh a patient during the lifting procedure.

The scale has been designed to weigh hospital or care facility patients under the supervision of trained nursing staff. All other uses must be avoided.

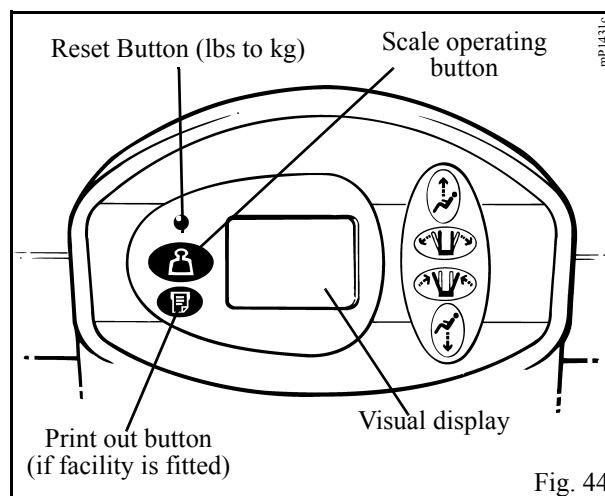

Scale Labels

On the labels relating to the Scale you will find the following information:-

Rating and Battery Size Label

(attached to the plate behind the lifter battery)

Weight range 1 = 2kg - 120kg (4lbs - 264.6lbs)

d = e 100g (0.2lbs)

Weight range 2 = 4kg - 190kg (10lbs - 419lbs)

d = e 200g (0.5lbs)

d = Actual Scale Division

Serial number label

(attached to the plate behind the lifter battery)

Using your Sara Plus

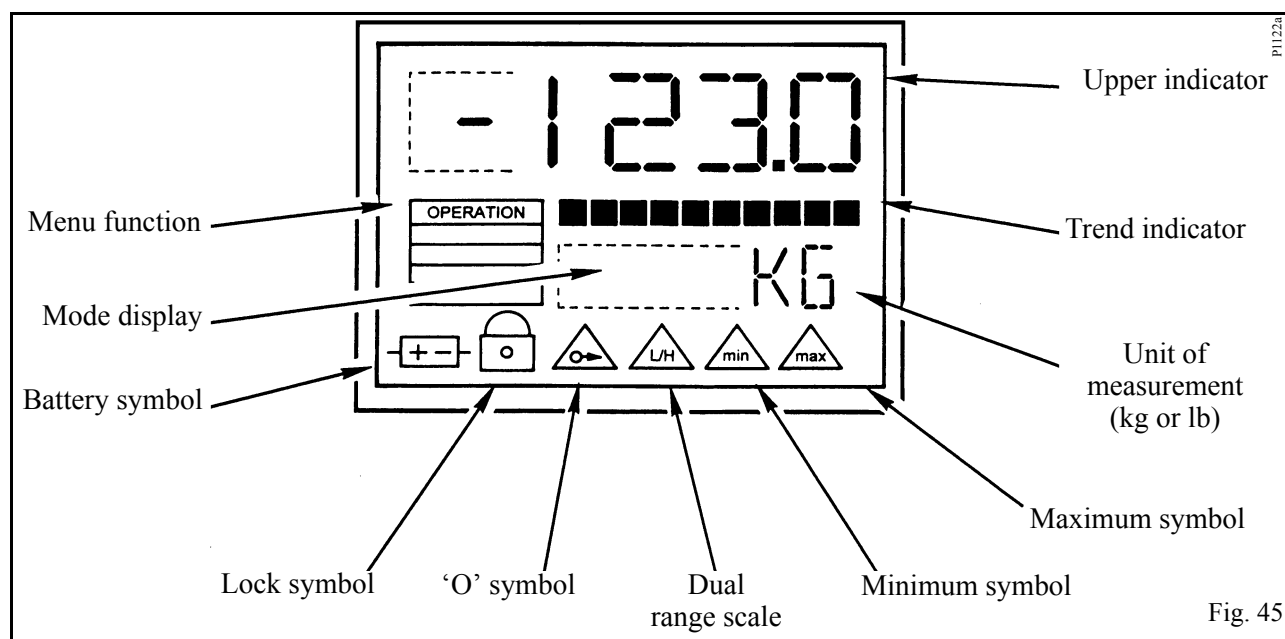

Scale Display

The scale has an LCD which displays various numbers and symbols which are explained below (see Fig. 45).

Display symbols /functions

Menu Functions

Shows "Operation" function.

Other functions are only available when calibrating.

Mode Display

B/G – Gross Weight

NET – Net Weight

Battery Symbol

If on – battery power is low.

(Approximately 1 hour of operation left).

All digits flashing – batteries are exhausted.

Lock symbol

Input password. (Only available for special and configuration functions. Contact ARJO Service Department if a password is required).

'0' symbol

Displayed when the Scale is in zero range, 25g (0.05lbs).

Dual range symbol

L = Low: 2kg-120kg (4lbs-264.4lbs)

H = High: 4kg-190kg (10lbs-418lbs)

The symbol is displayed for weights over 120kg (264.6lbs).

Min symbol

Displayed when the load is below 2kg (4lbs).

Max symbol

Displayed when the load is above 191.8kg (422.5lbs). If the Scale is overloaded, remove the load immediately. Do not move the Scale/lifter until the symbol is switched off.

Trend indicator

Visual weighing range indicator. Blocks are displayed which increase from left to right as loading increases.

Unit of measurement

The unit of measurement, in either 'kg' or 'lbs' will be preset before delivery. If, for any reason you need to change from 'kg' to 'lbs', press the operating button for a minimum of 10 seconds.

Upper indicator

Shows weight in kilograms or pounds.

(-) shows, when weight is negative. (See section "Weighing with the Patient already suspended in the sling.").

Using your Sara Plus

To return to the 'kg' setting use a ball point pen or similar to press the reset button (small dot recess). Situated on the scale display panel (see Fig. 46).

Only weigh a patient when they are completely suspended with feet on the foot support. Do not attempt to weigh when the patient is sitting either in a chair or on the commode seat (if fitted).

There are two methods to weigh the patient:-

Method "A" Weighing before the patient is suspended in the sling.

Press the scale operating button (see Fig. 46).

- **Note:** *With agitated patients the attendant should wait until the patient is calm before attempting to weigh.*

A display test is performed, all segments of the display are shown for approximately one second.

The display will show 'WAIT' and after some seconds will display the mode that the scale is in.

Hang the sling to be used over the Patient Support arms and press the operating button again.

The scale will display "NET 0.0" (see Fig. 46).

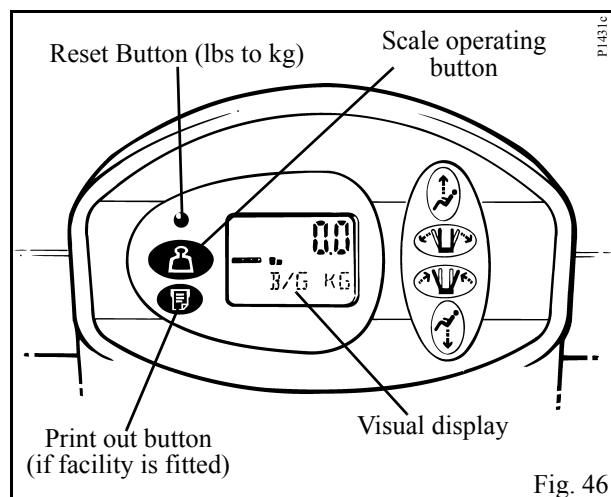

This procedure is to "Zero Out" (Tare) the Scale, to take account of the weight of accessories, e.g. sling etc.

Remove the sling and position it around the patient, as in normal lifting procedure.

Lift the patient until clear of any obstructions, e.g. chair, bed, commode seat (if fitted) etc.

Ensure the patient's feet are securely on the foot support.

Do not press the button again – the number displayed will be the weight of the patient.

IMPORTANT: Do not touch or lean on the patient or lifter during the weighing operation.

- **Note:** *The scale, once switched on will operate for 6 minutes. After this time, the scale will automatically switch off. Should this happen, press the button again.*



Caution: Do not overload the scale. If the scale unit displays "MAX", remove the patient immediately.

Method "B" Weighing with the patient already suspended in the sling.

Ensure the patient is suspended free and clear of any obstructions, e.g. chair, bed, commode seat (if fitted) etc.

Press the scale operating button (see Fig. 46).

- **Note:** *With agitated patients the attendant should wait until the patient is calm before attempting to weigh.*

A display test will be performed, all display segments are shown for approximately one second.

The display will show 'WAIT' and after some seconds will display the mode that the scale is in.

Ignore the weight displayed, and press the operating button again.

The scale will display "NET 0.0" (see Fig. 46)

Lower the patient to a suitable position and remove the sling, then leave the patient sitting comfortably and move the lifter away from the patient.

Hang the sling over the Patient Support arms.

The weight is displayed, and although having a minus (-) sign in front of it, is the weight of the patient.

Remove the sling.

IMPORTANT: Do not touch or lean on the patient or lifter during weighing.

Using your *Sara Plus*

- **Note:** *The scale, once switched on will operate for 6 minutes. After this time, the scale will automatically switch off. Should this happen, press the button again.*



Caution: Do not overload the scale. If the scale unit displays “MAX”, remove the patient immediately.

- **Note:** *It is permissible to “Zero Out” (Tare) during operation.*

With the scale apart from cleaning, no other special maintenance should be required.

Calibration

ARJO recommend that your scale is checked every 12 months for accuracy and the calibration adjusted if necessary. This must be carried out by an ARJO service engineer. For more information contact your local Arjo distributor.

Battery Charging



Warning: The charging of the battery must only be performed away from the patient environment.

The charger is for indoor use only.

Only use the charger unit in a dry environment, do not use it in the bathroom.

Do not expose the charger unit or battery pack to rain or spray and do not immerse in water.

Do not expose the charger unit to dust.

To avoid overheating, the charger must not be covered whilst in use.

No smoking or naked flames in battery vicinity.

The battery charger is for use only with ARJO supplied batteries that are to be used with the *Sara Plus*.

The battery charger is for use with sealed lead acid batteries only.

Under no circumstances should the charger be used to attempt to recharge non-rechargeable batteries.

Do not attempt to open or tamper with the charger unit in any way, for any repair the charger must be sent to the manufacturer.

The mains electricity socket must be easily accessible. Should a faulty condition occur switch off and remove the connection plug from the socket.

Only use ARJO components that have been specifically designed for the purpose when charging batteries

Only use the ARJO battery that is supplied to be used with the *Sara Plus*.

Only use the ARJO charger unit supplied with the *Sara Plus*.

Do **NOT** charge batteries in a sealed container.

Do **NOT** place batteries near, or dispose of, in a fire.

Do **NOT** short circuit a battery.

Do **NOT** store batteries at temperatures in excess of 60°C (140°F).



Warning: Do **NOT** crush, puncture, open, dismantle or otherwise mechanically interfere with batteries.

Should the battery casing become cracked, and electrolyte come into contact with skin or clothing, wash immediately with water.

Should the battery casing become cracked, and electrolyte come into contact with skin or clothing, wash immediately with water.

If the electrolyte contacts the eyes, wash immediately with copious amounts of water, and seek medical attention.

When disposing of batteries, contact the appropriate local authority for advice.

The abbreviation “Pb” shown adjacent to the recycling and trash bin symbols on the battery back label is the element symbol for lead, and indicates that the battery contains lead and therefore should not be disposed of in the normal manner but must be recycled.

- **Note:** *Ensure the battery is removed from the lifter if it is anticipated it will not be used for a prolonged period of time.*

For more details of caring for your lifter battery refer to ARJO ‘Battery Care’ literature, Part No. KDX01660.GB.

The *Sara Plus* incorporates a battery discharge indicator, situated on the right hand side of the cover (see Fig. 1). The display shows ten levels of battery state ranging from fully charged on the right to very low on the left (green, through yellow to red).

- **Note:** *The battery discharge indicator has an energy saving function which automatically switches off the display if a function button has not been operated for at least 30 seconds. The moment a button is pressed to operate any function the display will re-start.*

It is recommended that the battery is removed from the lifter and recharged when the display reaches the yellow range, but lifting is possible until the display shows the red flashing light, at this point, the battery must be recharged as soon as possible.

Recharging the battery pack before it reaches a low state of battery charge or certainly totally discharged will prolong its life.

Battery Charging

Your lifter is fitted with an audible warning device this will sound when the battery discharge indicator reaches the red light range.

To ensure the *Sara Plus* is always ready for use, it is recommended that a freshly charged battery pack is always available. This is achieved by having additional battery packs available and keeping one on charge while the other is in use.

It may be considered good protocol to have a freshly charged battery ready for the start of every work shift.

- **Note:** *Whichever level the indicator has reached, once a fully charged battery is re-inserted into the lifter, the display will return to the green fully charged position, but if a partially charged battery is re-inserted, the level at which the indicator had reached will remain, even though the recently inserted battery may be in a better state of charge than indicated. To achieve a true indication of battery state a fully charged battery must be inserted into the lifter to reset the indicator.*

Place the battery pack on charge as follows:



Caution: Ensure the mains power to the charger unit is switched off before connecting the battery.

- **Note:** *The cable that connects the main electricity supply to the charger is supplied as a detachable item. If using the battery charger for the first time or if the cable has been unplugged from the charger, connect the cable fully into the charger before connecting to the mains electrical socket.*



Warning: Always ensure the cable connection plugs that fit into the charger and into the battery are fully inserted before switching on mains electricity.

When the LEDs on the battery discharge indicator display amber, complete your lift cycle then take the lifter to a convenient situation and remove the battery pack by holding the grip position of the battery and pressing the release catch situated above, pivot the battery away and lift clear. Take the battery to the battery charger unit and ensure the battery is positioned securely then insert the battery connector from the charger into the corresponding

connector in the back of the battery, switch on mains power. An orange light will be displayed on the charger unit when the battery is totally discharged. This will change to a yellow light as the battery approaches full charge capacity, finally changing to a green light when the battery is fully charged.

A discharged battery should be left approximately 8 hours to totally recharge (See also ARJO Battery Care document).



Warning: Hold the pack firmly to ensure it does not drop and become damaged, or cause personal injury.

- **Note:** *The battery pack may be left connected to the charger unit when it is fully charged without being damaged by overcharging, this will also ensure the battery is kept fully charged.*



Caution: Always disconnect the mains supply before disconnecting the battery from the charger unit.

When the battery pack is fully charged, disconnect the mains power, remove the battery pack from the charger, and insert it back into the *Sara Plus* battery position.

Ensure the green reset button (situated on the rear of the mast) is pressed in (see Fig. 1).

The *Sara Plus* is now ready for use.

Care of your *Sara Plus*

General Lifter Care

How often the following actions are taken depends on how often the equipment is used.

Unless otherwise stated, it is a good idea to begin once a week and then rely on experience to decide how often it is necessary in the future.



Warning: The slings should be checked, and if necessary washed according to instructions on the sling, also refer to sling instruction sheet MAX.01520.INT.

The Polyester fleece sling cover may be removed from the sling cushion assembly for laundering. To remove the cover, undo the tie cords at each end of the sling, open up the 'Velcro' seam and remove. Secure the tie cords with a knot before laundering.



Warning: With regard to laundering, slings should not be classified as linen, but as an accessory to a patient transfer lifter and therefore classified as a medical device. Slings should be cleaned and disinfected only in strict accordance with the manufacturers instructions.

ARJO strongly recommends that the support strap is removed from the sling prior to washing, this is to prevent 'velcro' hook damage to the fabric of the sling. The support strap should be washed separately with the 'velcro' patches in the 'closed' position i.e.: fold the strap, over on itself and press 'velcro' mating halves together. Always ensure the support strap is reconnected to the sling before use.

Mechanical pressure should be avoided during the washing and drying procedure e.g. rolling or pressing, as these can damage parts vital to the safe and comfortable operation of the sling.

It is recommended that ARJO Patient lifters, equipment, accessories and slings are regularly cleaned. If the slings, lifters and equipment needs cleaning, or are suspected of being contaminated, follow the cleaning and/or disinfection procedures recommended below, before re-using the equipment. This is especially important when using the same equipment for another patient, to minimise the risk of cross infection.

For cleaning your lifter, equipment and accessories wipe down with a damp cloth using warm water to which a disinfectant/cleaner has been added e.g. "ARJO CLEAN" - disinfectant/cleaner or equivalent.

- **Note:** *ARJO CLEAN* - disinfectant cleaner is available from ARJO. or their approved distributors.



Caution: Do not over wet areas of the product which could cause problems with electrical components or internal corrosion.

If a hot air dryer is used to dry the lifter, the temperature must not exceed 80°C (176°F).

Do not use petroleum based solvents or similar, since this may damage plastic parts.



Warning: For disinfection of contaminated lifters, equipment and accessories, use the preferred method of wiping the product completely with "hard surface disinfectant wipes" that are supplied impregnated with a 70% v/v solution of Isopropyl Alcohol.

- **Note:** *A rubbing action will be necessary when using the wipes to promote effective disinfection of the surfaces.*



Warning: IMPORTANT: Cleaning and disinfection products must be used in accordance with the manufacturers instructions and suitable eye, hand and clothing protection must be worn at all times when handling disinfectants.

- **Note:** *70% v/v Isopropyl Alcohol wipes have been proved to be effective against MRSA and several other micro-organisms under light soiling conditions.*

Ensure that the battery pack is always in a good state of charge.

Check that the lifter can be propelled in a normal manner, making sure that the castors are quite free in their movement, as clogging by hair and fluff can occur, also check that the tread of the castor is not damaged.

Care of your *Sara Plus*



Warning: Ensure that the castors are firmly secured to the chassis.

Carefully inspect all parts, in particular where there is personal contact with the patient's body, ensure that no cracks or sharp edges have developed which could injure the patient's skin or become unhygienic.

It is essential that the sling attachment cords, the slings, their straps and attachment clips are carefully inspected before each and every use. If the slings, cords or straps are frayed, or the clips damaged, the sling or attachment cord should be withdrawn from use immediately and replaced.

Check that all external fittings are secure and that all screws and nuts are tight.

Ensure that all instruction labels are firmly attached and in good readable condition.

Adjustable Width Chassis Function:- Open and close the chassis legs using the control handset to check for full and efficient movement.

General Lifter Condition:- A general visual inspection of all external parts should be carried out, and all functions should be tested for correct operation, to ensure that no adverse damage has occurred during use.



Warning: If in any doubt about the correct functioning of the *Sara Plus*, withdraw it from use and contact ARJO Service Department.

Cleaning and Disinfecting the Toilet Commode Chair and Frame (if fitted)

For exterior areas of the seat and frame the "hard surface disinfectant wipes" mentioned above will be very effective, but for internal and crevice areas of the equipment ARJO recommend that the seat and frame is cleaned in accordance with your normal cleaning and disinfecting protocol.

Environmental Advice

When disposing of any items associated with the lifter, contact the appropriate local authority for advice.

Periodic Testing

For normal operation - raise and lower the Patient Support arms using the control handset and dual control panel, this is to test for full and efficient movement.

Automatic Stop Function:- With the Patient Support arms raised well above its lowest position, using the control handset lower it, and at the same time with your other hand hold the Patient Support arms up briefly. The motor will continue to run while the Patient Support arms weight is held, this is quite normal, release the button, then lower the Patient Support arms carefully. Repeat this check using the dual control lower button on the lifter. This check is for the correct function of the automatic stop.

Emergency Stop:- Test the emergency stop facility by operating the control handset to lift or lower the patient support arms, and whilst operating, press in the emergency stop button. (See Fig. 1). Powered movement should stop immediately.

Reset to normal function by pressing the green reset button. (See Fig. 1). Repeat for chassis legs opening / closing function, and reset the button.

Dis-assembly of the Commode Seat

Remove the plastic commode seat from the seat frame by pulling the rear edge up sharply to disengage the locating lugs (see Fig. 47). Slide the seat forwards a short distance until clear of the frame tubes and lift away.

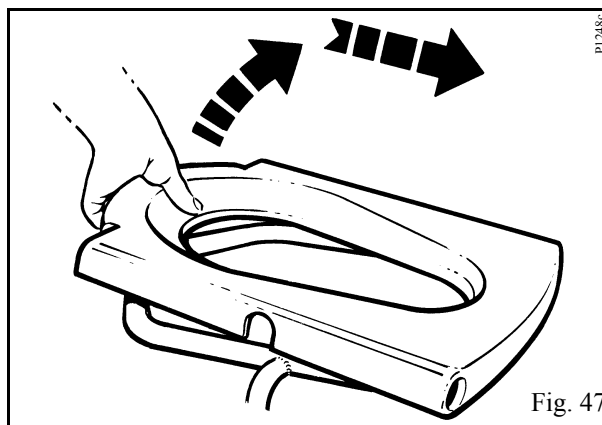

To refit the commode seat, locate the seat holes over the seat frame tubes, and align the location lugs over the rear cross bar of the seat frame as shown in Fig. 48. Apply sharp downward blows onto the rear of the seat, (as shown in Fig. 49), in two places directly above the location lugs, until the seat 'snaps' back into place.

Care of your *Sara Plus*

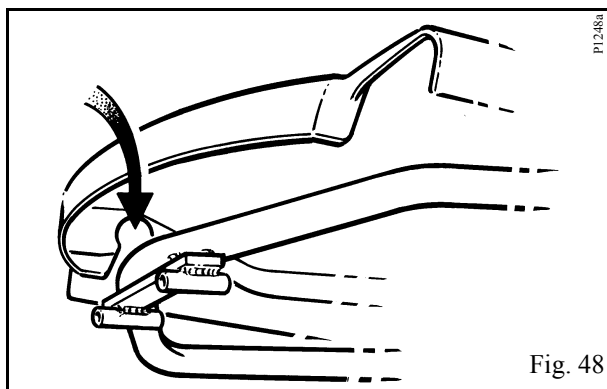

Warning: Always ensure the seat is secure before allowing a patient to use it.

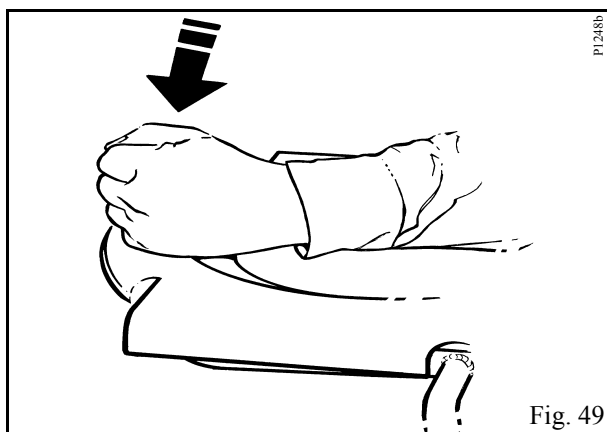

Servicing Advice

Warning: Arjo recommend that the *Sara Plus* is maintained at regular intervals, see Arjo Sara Plus Preventative maintenance schedule literature Part No. PMS001.

With regular use the following items are subject to wear:- Slings, batteries, sling cords, straps, castors. These items must be regularly checked as described previously, and replaced as necessary.

Warning: UK LIFTERS ONLY: Important legislation came into force on 5th December 1998, which has an impact on the schedule of service for your patient lifter(s), variable height baths and other raising and lowering equipment. The Lifting Operations and Lifting Equipment Regulations (LOLER) 1998 and The Provision and Use of Work Equipment Regulations (PUWER 98) must be satisfied by the duty holder. A scheme of six monthly thorough examinations has been devised to comply with the law and details can be obtained from ARJO Service UK

Parts lists and circuit diagrams are available from ARJO or their approved distributors on request.

Warning: Spare parts, if required are available from ARJO or their approved distributors.

Special tools are required for certain component replacement.

Warning: The simplest; safest and most effective way to maintain your product in good working order, is to have it methodically and professionally serviced by an ARJO approved engineer using ARJO approved spare parts.

For information on service and maintenance contracts, please contact your local ARJO distributor.

Labels

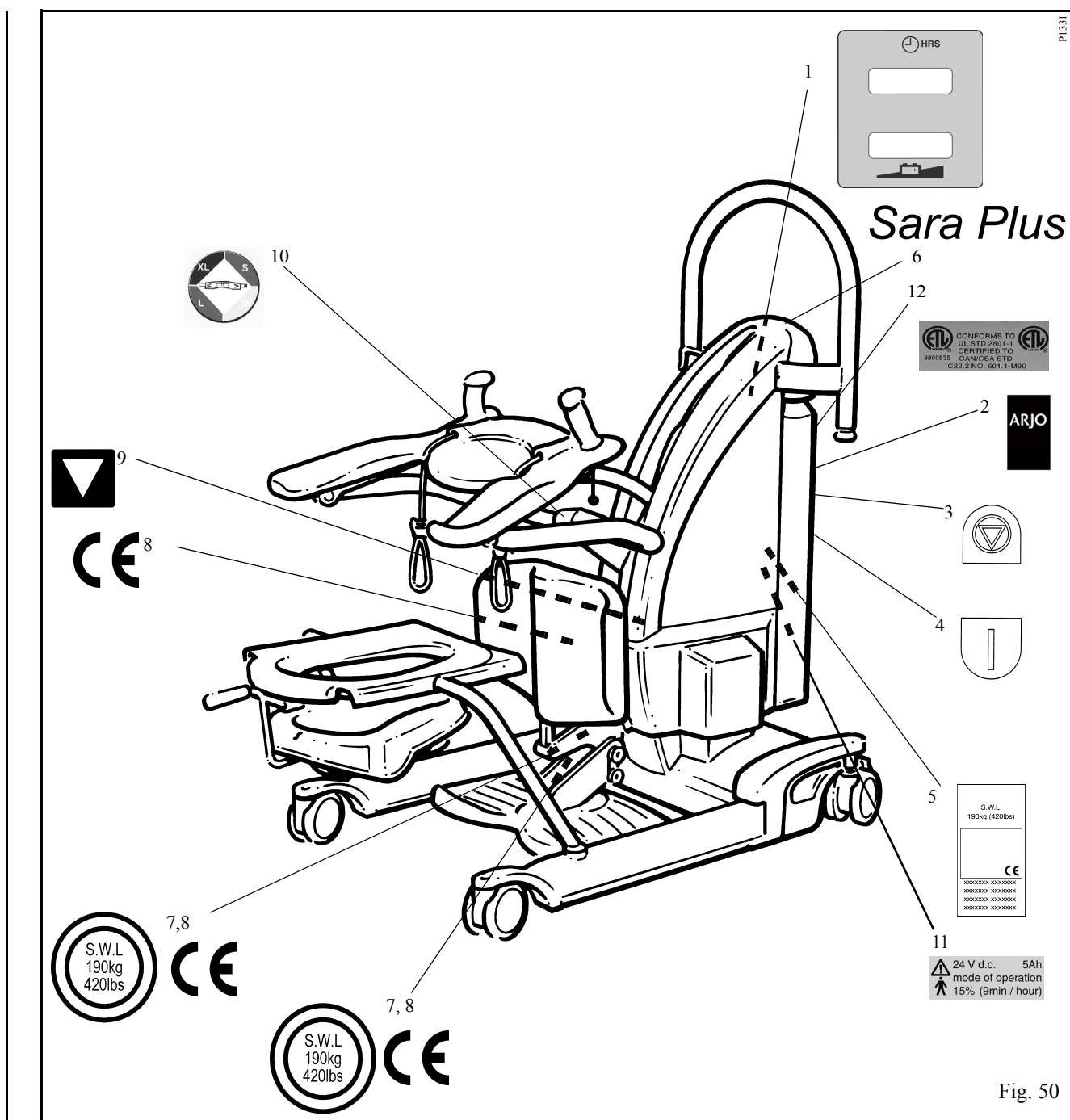

Fig. 50

- | | |
|---|---|
| 1. Label - Battery discharge indicator and hour meter | 7. Label - Safe working load 190kg (420 lbs) |
| 2. Label - ARJO logo | 8. Label - CE mark |
| 3. Label - Emergency stop button identification | 9. Label - System failure lower override identification |
| 4. Label - Reset button identification | 10. Label - Sling size guide |
| 5. Label - Address and SWL 190kg (420 lbs) | 11. Label - Electrical information |
| 6. Label - "Sara Plus" | 12. Label - UL / CSA approval (US/Canada only) |

Technical Specification

	kg	lbs
Maximum weight limit to be lifted or carried (when using 'standing sling')	190	(420)
Maximum weight limit to be lifted or carried (when using 'transfer and walking sling' for walking practice only)	190	(420)
Maximum weight limit to be lifted or carried (when using the 'transfer and walking sling' for transfer operation only)	140	(308)
Maximum weight limit to be carried (when using 'toilet commode seat and frame').	190	(420)

Component Weights

	kg	lbs
Sara Plus - non scale version (complete - less battery)	75.0	(165.3)
Sara Plus - scale version (complete - less battery).	85.6	(188.7)
Battery pack	4.9	(10.8)
Commode seat and frame (option).4	(.8)
Commode pan and holder (option).	1.2	(2.6)
Foot support	4.5	(10)

Electrical

Battery type and part number	(Rechargeable - lead acid) KPA0100
Battery capacity	5Ah
Battery charger part number	KPA0101**
	(Note:** indicates relevant country code)
Protection class lifter	IPX 4
Protection class handcontrol.	IPX 67
Lifter nominal voltage	24V DC

Medical Equipment:- type B ⚡ protection against electrical shock in accordance with IEC 601-1)
 Arjo patient handling products meet the requirements of Electromagnetic Compatibility (EMC) as stated in clause 12.5 of the Medical Devices Directive 93/42/EEC

 Although compliant with EMC requirements there is a remote chance that close proximity usage may affect over-sensitive electrical equipment

	Duty cycle	Max volts	Max amps
Mast Lift Actuator (sealed electro-hydraulic unit).	15% (9 min/hr)	24	20
'V' Chassis Actuator (electro-mechanical unit).	10% (6 min/hr)	24	4

Maximum sound power level

In accordance with ISO 3746. 74dB (dB re 1pW ± 3dB)

Scale

Power supply	Main lifter battery
Protection class.	IP 53
Accuracy (standard scale) 2-50kg (4-110lbs)	±.5kg (1.1lbs)
Accuracy (standard scale)50-120kg (110-265lbs).	±.5kg (1.1lbs)
Accuracy (standard scale)120-190kg (265-420lbs).	±.5kg (1.1lbs)

Environment

Air humidity	80% @ 20°C (68°F)
Usage temperature range (ambient)	+5°C (41°F) to +35°C (95°F)
Optimum usage temperature (ambient)	+20°C (68°F) to +25°C (77°F)
Storage and transportation temperature (ambient)	-10°C (14°F) to +45°C (113°F)

Technical Specification

Lifter Dimensions

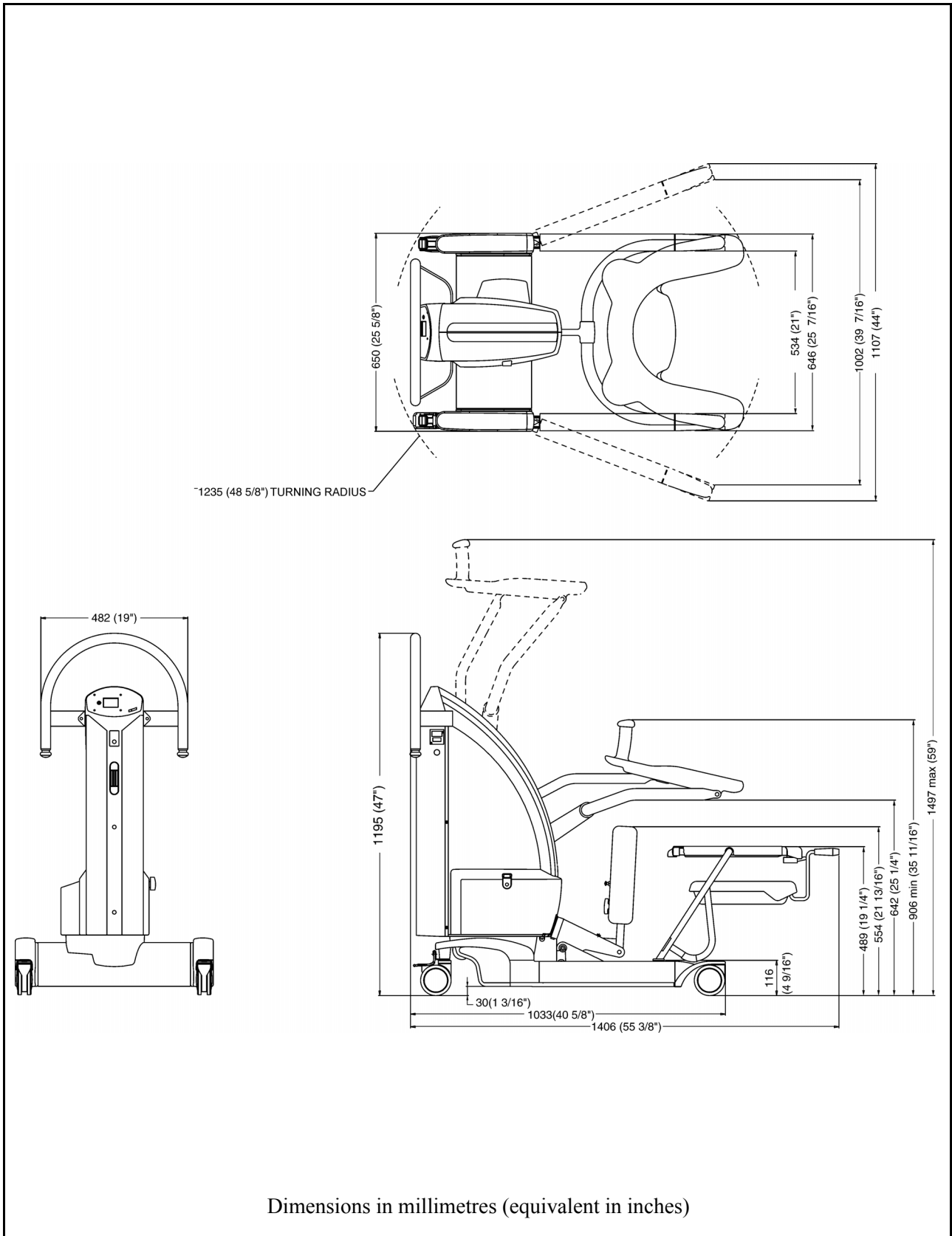

AUSTRALIA

ARJO Hospital Equipment Pty. Ltd.
205 Queensport Road, Murarrie,
Brisbane QLD 4172, Australia

PO Box 675, Bulimba
Brisbane QLD, 4171, Australia
Tel. (61) 7 3395 6311
Fax. (61) 7 3395 6712
Email: info@arjoaustralia.com.au

SVERIGE

ARJO SCANDINAVIA AB
Box 61, 241 21 Eslov, Sweden
Tel. +46 413-645 00
Fax. +46 413-645 83
E-post: kundservice@arjo.se

DANMARK

ARJO SCANDINAVIA
Postboks 51, 4632 Bjæverskov
Tel. 45 93 27 37
Fax. 45 93 27 39
E-post: kundservice@arjo.se

NORGE

ARJO SCANDINAVIA
Enebakkveien 117 d, 0680 Oslo
Tel. 98 28 11 70
Fax. 23 05 11 99
E-post: kundservice@arjo.se

BELGIQUE / BELGIË

ARJO N.V. Hospital Equipment S.A.
Ternesselei 243
2160 WOMMELGEM
Tel. 03/353 91 00
Fax. 03/353 91 01
Email: info@arjo.be

CANADA

ARJO Canada Inc.
1575 South Gateway Road
Unit C, Mississauga, ONTARIO
L4W 5J1
Tel. 1 800 665 4831
Fax. 1 800 309 1116

ČESKÁ REPUBLIKA

ARJO Hospital Equipment s.r.o.
Strmá 35
CZ-616 00 BRNO
Tel. 549 254 252
Fax. 541 213 550

DEUTSCHLAND

ARJO GmbH
Christof-Ruthof-Weg 6
55252 Mainz-Kastel, Germany
Tel. +49 (0)61 34-186 211
Fax. +49 (0)61 34-186 209
Email: info@arjo.de

ESPAÑA

ARJO SPAIN, S.A.
C/ San Rafael, nº 6
28108 ALCOBENDAS (MADRID)
SPAIN
Tel. +34 902 300 126
Fax. +34 902 300 191
Email: arjospain@arjospain.es

FRANCE

ARJO Equipements Hospitaliers
S.A.
45, Avenue de l'europe
Eurocit BP133
F-59436 RONCQ CEDEX
FRANCE
Tel. 03 20 28 13 13
Fax. 03 20 28 13 14
Email: info@arjo.fr

GREAT BRITAIN

ARJO MED AB Ltd.
St. Catherine Street
Gloucester, GL1 2SL
ENGLAND U.K.
Tel. (08702) 430430
Fax. (01452) 428344

IRELAND

ARJO Ireland Ltd, EA House,
Damastown Industrial Estate,
Mulhuddart, Dublin 15, Eire
Tel. 00 35 31 8098960
Fax. 00 35 31 8098971

HONG KONG

ARJO Far East Ltd.
1001-1003 APEC Plaza,
49 Hoi Yuen Road, Kwun Tong,
Kowloon, HONG KONG
Tel. 852 2908 9553
Fax. 852 2508 1416

ITALIA

ARJO Italia SPA
Via Tor Vergata,
432 - 00133 ROMA
Tel. 06 87426211
Fax. 06 87426222
Email: promo@arjo.it

NEDERLAND

ARJO NEDERLAND B.V.
De Blomboogerd 8,
4003 BX TIEL,
Postbus 6116,
4000 HC TIEL
Tel. +31 (0)344 64 08 00
Fax. +31 (0)344 64 08 85
Email: info@arjo.nl

ÖSTERREICH

ARJO GmbH, Föhrenweg 5,
A-6065 THAUR, Austria
Tel. +43 (0)5223 493350
Fax. +43 (0)5223 493350 75
Email: office@arjo.at

POLAND

Getinge POLAND Sp. z o.o.
02-387 Warszawa
ul. Lirowa 27
Poland
Tel. +48 22 882-06-26..28
Fax +48 22 882-24-52
Email: wysokinski@getinge.pl

SCHWEIZ / SVIZZERA

ARJO INTERNATIONAL AG
Florenzstr. 1d, Postfach,
CH-4023 BASEL, Switzerland
Tel. +41 (0)61 337 9797.
Fax. +41 (0)61 331 4780
Email: arjo.international@arjo.com

SCHWEIZ

ARJO-SIC AG
Florenzstr. 1d, Postfach
4023 BASEL
Tel. +41 (0)61 337 97 77
Fax. +41 (0)61 311 97 42
Email: arjo.sic@arjo.ch

USA

ARJO, Inc.
50 North Gary Avenue
Roselle, IL 60172
Tel. 1-800-323-1245
Fax. 1-888-594-ARJO(2756)

ARJO

www.arjo.com



If your country is not listed here, please contact your local distributor, or ARJO International AB, Box 61, S-241 21 ESLÖV, SWEDEN.

GETINGE GROUP is a leading global provider of equipment and systems that contribute to quality enhancement and cost efficiency within healthcare and life sciences, equipment, services, and technologies are supplied under the brands ARJO for resident hygiene, resident handling and wound care, GETINGE for infection control and prevention within healthcare and life science and MAQUET for surgical workplaces, cardiopulmonary and critical care.